

MVME147S

MPU VMEmodule User's Manual

**MVME147S/D3
April 2000 Edition**

Notice

While reasonable efforts have been made to assure the accuracy of this document, Motorola, Inc. assumes no liability resulting from any omissions in this document, or from the use of the information obtained therein. Motorola reserves the right to revise this document and to make changes from time to time in the content hereof without obligation of Motorola to notify any person of such revision or changes.

Electronic versions of this material may be read online, downloaded for personal use, or referenced in another document as a URL to the Motorola Computer Group website. The text itself may not be published commercially in print or electronic form, edited, translated, or otherwise altered without the permission of Motorola, Inc.

It is possible that this publication may contain reference to or information about Motorola products (machines and programs), programming, or services that are not available in your country. Such references or information must not be construed to mean that Motorola intends to announce such Motorola products, programming, or services in your country.

Limited and Restricted Rights Legend

If the documentation contained herein is supplied, directly or indirectly, to the U.S. Government, the following notice shall apply unless otherwise agreed to in writing by Motorola, Inc.

Use, duplication, or disclosure by the Government is subject to restrictions as set forth in subparagraph (b)(3) of the Rights in Technical Data clause at DFARS 252.227-7013 (Nov. 1995) and of the Rights in Noncommercial Computer Software and Documentation clause at DFARS 252.227-7014 (Jun. 1995).

Motorola, Inc.
Computer Group
2900 South Diablo Way
Tempe, Arizona 85282

Preface

This manual provides general information, hardware preparation, installation instructions, operating instructions, programming, and functional descriptions for the MVME147S series MPU VMEmodules.

This manual is intended for anyone who wants to design OEM systems, supply additional capability to an existing compatible system, or in a lab environment for experimental purposes.

A basic knowledge of computers and digital logic is assumed. To use this manual, you should be familiar with the publications listed in [Motorola Computer Group Documents on page 1-6](#).

Motorola® and the Motorola symbol are registered trademarks of Motorola, Inc.

MVME147bug, VMEmodule, and VMEsystem 1000 are trademarks of Motorola, Inc.

All other products mentioned in this document are trademarks or registered trademarks of their respective holders.

© Copyright Motorola, Inc. 1989, 1990, 1992, 2000
All Rights Reserved

Printed in the United States of America
2000

Safety Summary

The following general safety precautions must be observed during all phases of operation, service, and repair of this equipment. Failure to comply with these precautions or with specific warnings elsewhere in this manual violates safety standards of design, manufacture, and intended use of the equipment. Motorola, Inc. assumes no liability for the customer's failure to comply with these requirements.

The safety precautions listed below represent warnings of certain dangers of which Motorola is aware. You, as the user of the product, should follow these warnings and all other safety precautions necessary for the safe operation of the equipment in your operating environment.

Ground the Instrument.

To minimize shock hazard, the equipment chassis and enclosure must be connected to an electrical ground. If the equipment is supplied with a three-conductor AC power cable, the power cable must be plugged into an approved three-contact electrical outlet, with the grounding wire (green/yellow) reliably connected to an electrical ground (safety ground) at the power outlet. The power jack and mating plug of the power cable meet International Electrotechnical Commission (IEC) safety standards and local electrical regulatory codes.

Do Not Operate in an Explosive Atmosphere.

Do not operate the equipment in the presence of flammable gases or fumes. Operation of any electrical equipment in such an environment constitutes a definite safety hazard.

Keep Away From Live Circuits.

Operating personnel must not remove equipment covers. Only Factory Authorized Service Personnel or other qualified maintenance personnel may remove equipment covers for internal subassembly or component replacement or any internal adjustment. Do not replace components with power cable connected. Under certain conditions, dangerous voltages may exist even with the power cable removed. To avoid injuries, always disconnect power and discharge circuits before touching them.

Use Caution When Exposing or Handling a CRT.

Breakage of a Cathode-Ray Tube (CRT) causes a high-velocity scattering of glass fragments (implosion). To prevent CRT implosion, avoid rough handling or jarring of the equipment. Handling of a CRT should be done only by qualified maintenance personnel using approved safety mask and gloves.

Do Not Substitute Parts or Modify Equipment.

Because of the danger of introducing additional hazards, do not install substitute parts or perform any unauthorized modification of the equipment. Contact your local Motorola representative for service and repair to ensure that safety features are maintained.

Observe Dangerous Procedure Warnings.

Warnings, such as the example below, precede potentially dangerous procedures throughout this manual. Instructions contained in the warnings must be followed. You should also employ all other safety precautions which you deem necessary for the operation of the equipment in your operating environment.



Dangerous voltages, capable of causing death, are present in this equipment. Use extreme caution when handling, testing, and adjusting.

All Motorola PWBs (printed wiring boards) are manufactured by UL-recognized manufacturers, with a flammability rating of 94V-0.



This equipment generates, uses, and can radiate electromagnetic energy. It may cause or be susceptible to electromagnetic interference (EMI) if not installed and used in a cabinet with adequate EMI protection.

CE Notice (European Community)



This is a Class A product. In a domestic environment, this product may cause radio interference, in which case the user may be required to take adequate measures.

Motorola Computer Group products with the CE marking comply with the EMC Directive (89/336/EEC). Compliance with this directive implies conformity to the following European Norms:

EN55022 “Limits and Methods of Measurement of Radio Interference Characteristics of Information Technology Equipment”; this product tested to Equipment Class A

EN50082-1:1997 “Electromagnetic Compatibility—Generic Immunity Standard, Part 1. Residential, Commercial and Light Industry”

System products also fulfill EN60950 (product safety) which is essentially the requirement for the Low Voltage Directive (73/23/EEC).

Board products are tested in a representative system to show compliance with the above mentioned requirements. A proper installation in a CE-marked system will maintain the required EMC/safety performance.

In accordance with European Community directives, a “Declaration of Conformity” has been made and is on file within the European Union. The “Declaration of Conformity” is available on request. Please contact your sales representative.

Contents

CHAPTER 1 General Information

Introduction.....	1-1
Model Designations	1-1
Features	1-2
Specifications	1-3
Cooling Requirements	1-4
FCC Compliance.....	1-5
General Description	1-6
Motorola Computer Group Documents	1-6
Related Specifications.....	1-7
Manual Terminology.....	1-8

CHAPTER 2 Hardware Preparation and Installation

Introduction.....	2-1
Unpacking Instructions	2-1
ROM Configuration Select Headers (J1, J2)	2-4
System Controller Select Header (J3).....	2-9
Factory Use Only Headers (J5, J6)	2-9
Serial Port 4 Clock Configuration Select Headers (J8, J9).....	2-10
Installation Instructions.....	2-10

CHAPTER 3 Operating Instructions

Introduction.....	3-1
Controls and Indicators	3-1
RESET Switch S2.....	3-1
Remote Reset Switch Connector (J4)	3-1
ABORT Switch S1	3-2
FAIL Indicator (DS1).....	3-2
STATUS Indicator (DS2).....	3-2
RUN Indicator (DS3).....	3-2
SCON Indicator (DS4).....	3-2
Memory Maps	3-4
MC68030 Memory Map	3-4
Program and Data Address Spaces	3-5

CPU Address Space.....	3-7
Coprocesor Register Map	3-8
Interrupt Acknowledge Map	3-8
VMEbus Memory Map.....	3-9
VMEbus Accesses to MVME147S Onboard DRAM	3-9
VMEbus Short I/O Memory Map.....	3-11
VMEbus Interrupt Acknowledge Map	3-12

CHAPTER 4 Programming

Introduction	4-1
Programming The Peripheral Channel Controller	4-1
Table Address Register	4-1
Data Address Register	4-1
32-Bit Registers.....	4-2
16-Bit Registers.....	4-2
8-Bit Registers.....	4-2
Byte Count Register	4-3
Data Holding Register	4-3
Timer 1 Preload Register	4-4
Timer 1 Counter Register	4-4
Timer 2 Preload Register	4-4
Timer 2 Counter Register	4-4
Timer 1 Interrupt Control Register.....	4-5
Timer 1 Control Register.....	4-5
Timer 2 Interrupt Control Register.....	4-6
Timer 2 Control Register.....	4-7
AC Fail Interrupt Control Register.....	4-7
Watchdog Timer Control Register.....	4-8
Printer Interrupt Control Register.....	4-8
Printer Control Register.....	4-9
DMA Interrupt Control Register	4-10
DMA Control and Status Register.....	4-11
Bus Error Interrupt Control Register	4-11
DMA Status Register.....	4-12
Abort Interrupt Control Register	4-12
Table Address Function Code Register	4-13
Serial Port Interrupt Control Register.....	4-13
General Purpose Control Register	4-14
LAN Interrupt Control Register	4-15
General Purpose Status Register	4-16
SCSI Port Interrupt Control Register	4-16

Slave Base Address Register	4-17
Software Interrupt 1 Control Register.....	4-19
Interrupt Base Vector Register	4-20
Software Interrupt 2 Control Register.....	4-21
Revision Level Register	4-21
Printer Data Register.....	4-21
Printer Status Register	4-22
Programming the VMEchip	4-22
Programming the LCSR.....	4-23
System Controller Configuration Register	4-23
VMEbus Requester Configuration Register	4-24
Master Configuration Register	4-25
Slave Configuration Register.....	4-28
Timer Configuration Register.....	4-29
Slave Address Modifier Register.....	4-30
Master Address Modifier Register	4-32
Interrupt Handler Mask Register	4-32
Utility Interrupt Mask Register.....	4-33
Utility Interrupt Vector Register.....	4-34
Interrupt Request Register	4-35
VMEbus Status/ID Register	4-37
Bus Error Status Register	4-37
GCSR Base Address Configuration Register	4-37
Programming the GCSR	4-39
Global Register 0	4-39
Global Register 1	4-40
General Purpose CSR 0	4-42
General Purpose CSR 1-4.....	4-42

CHAPTER 5 Functional Description

Introduction.....	5-1
Functional Description.....	5-1
MC68030 MPU.....	5-1
MC68882 FPC	5-2
VMEchip.....	5-2
VMEbus System Controller.....	5-2
VMEbus Time-Out.....	5-2
System Clock Utility	5-3
Arbiter.....	5-3
IACK* Daisy-Chain Driver.....	5-3

System Reset Function (SYSRESET*).....	5-3
VMEbus Interrupter	5-4
Local Bus Time-Out.....	5-4
VMEbus Access Time-Out	5-4
VMEbus Master Interface	5-4
VMEbus Requester	5-5
VMEbus Slave Interface	5-6
Peripheral Channel Controller (PCC)	5-6
DMA Channel Controller.....	5-7
DMAC Initiation Mode.....	5-7
DMAC Operation States	5-8
Idle State.....	5-8
Data Transfer State.....	5-8
Table Walk State	5-8
DMAC Error Conditions.....	5-9
SCSI Data Bus Converter.....	5-9
SCSI Reset	5-9
SCSI Chip Interface	5-10
Programmable Tick Timers.....	5-10
Watchdog Timer.....	5-10
Printer Interface.....	5-10
Control and Status Registers	5-10
RESET and ABORT Switches.....	5-11
Power Up Reset.....	5-11
AC Fail Interrupter	5-11
RAM Refresh Timer	5-11
Serial Port Interface.....	5-11
Ethernet Interface	5-12
SCSI Interface	5-13
Data Bus Structure.....	5-13
Battery Backed Up RAM and Clock	5-14
ROM/PROM/EPROM/EEPROM	5-14
Device Timing Requirements	5-14
EEPROM Power Up/Power Down Considerations	5-17
Interrupt Handler	5-17
Front Panel Switches and Indicators	5-19
Onboard DRAM	5-19
MC68030 DRAM Accesses	5-20
PCC DRAM Accesses.....	5-20
VMEbus DRAM Accesses.....	5-20
LANCE DRAM Accesses.....	5-21
Refresh	5-21

Local Bus Multiport Arbiter	5-21
Reset.....	5-22
Sources of Bus Error (BERR*).....	5-22
Local Bus Time-Out	5-22
VMEbus Access Time-Out.....	5-22
VMEbus BERR*	5-23
Local RAM Parity Error	5-23
Bus Error Processing	5-23
MVME147S Support of MC68030 Indivisible Cycles.....	5-24

FIGURES

Figure 2-1. MVME147S Header Locations #.....	2-3
Figure 5-1. Timings Required by the MVME147S	5-15
Figure 5-2. Timings Guaranteed by MVME147S #ti299202	5-16
Figure 5-3. MVME147S Block Diagram.....	5-26

TABLES

Table 1-1. MVME147S Model Designations	1-1
Table 1-2. MVME147S Specifications	1-3
Table 3-1. Front Panel LEDs and MVME147S Status	3-3
Table 3-2. MVME147S Address Spaces.....	3-4
Table 3-3. MC68030 Main Memory Map.....	3-5
Table 3-4. Local I/O Devices	3-6
Table 3-5. MC68882 Register Map.....	3-8
Table 3-6. DRAM Address as Viewed from the VMEbus.....	3-9
Table 3-7. VMEchip GCSR as Viewed from the VMEbus.....	3-11
Table 4-1. PCC Overall View.....	4-2
Table 4-2. DRAM Address as Viewed from the VMEbus.....	4-17
Table 4-3. DRAM Accessed by the LANCE	4-19
Table 4-4. VMEchip Local Control and Status Registers	4-23
Table 4-5. Determining the Master AM Code	4-26
Table 4-6. Utility Interrupts and Their Assigned Level	4-34
Table 4-7. Encoding of the Interrupt ID.....	4-35
Table 4-8. Configuring the Interrupt Request Level	4-36
Table 4-9. VMEchip GCSR as Viewed from the VMEbus.....	4-38
Table 4-10. VMEchip GCSR	4-39
Table 5-1. Example DMA Table	5-9
Table 5-2. MVME147S Interrupt Sources and Vectors	5-17

Introduction

This manual provides general information, preparation for use and installation, operating instructions, and functional description for the MVME147S MPU VME module.

Model Designations

The MVME147S is available in several configurations which are summarized in the following table. The main differences between the versions are processor speed, and memory size.

Table 1-1. MVME147S Model Designations

Model Number	Clock Speed	Memory	Parity	Ethernet
MVME147S-1	25 MHz	4MB	Yes	Yes
MVME147SA-1	25 MHz	8MB	Yes	Yes
MVME147SA-2	32 MHz	8MB	Yes	Yes
MVME147SB-1	25 MHz	16MB	Yes	Yes
MVME147SB-2	32 MHz	16MB	Yes	Yes
MVME147SC-1	25 MHz	32MB	Yes	Yes
MVME147SC-2	32 MHz	32MB	Yes	Yes
MVME147SRF	16 MHz	4MB	No	No

Note The memory maps change for the 4, 8, 16, and 32MB versions. Refer to *Memory Maps* in Chapter 3.

Features

The features of the MVME147S include:

- ❑ MC68030 microprocessor
- ❑ Floating-Point Coprocessor (MC68882)
- ❑ Shared DRAM with parity (no parity on MVME147SRF)
- ❑ Four serial ports with RS-232C buffers
- ❑ Small Computer Systems Interface (SCSI) bus interface with DMA channel
- ❑ Time-of-day clock/calendar with battery backup
- ❑ CMOS RAM, 2K by 8 with battery backup
- ❑ Four ROM/PROM/EPROM/EEPROM sockets (organized as 16 bits wide)
- ❑ VMEbus interrupter
- ❑ VME bus system controller functions
- ❑ VMEbus master interface (A32/D32,A24/D16 compatible)
- ❑ VMEbus requester
- ❑ Status LEDs for SCON, DUAL, FAIL, and STATUS
- ❑ RESET and ABORT switches
- ❑ Centronics printer port
- ❑ Two 16-bit tick timers for periodic interrupts
- ❑ Watchdog timer
- ❑ Ethernet transceiver interface (except MVME147SRF)

Specifications

The MVME147S specifications are given in the following table.

Table 1-2. MVME147S Specifications

Characteristics	Specifications
Power requirements (MVME147S with two EPROMs and MVME712M) (power must be brought in from both the P1 and P2 backplanes or connectors P1 and P2)	+5 Vdc, 7.0 A max. (6.0 A typical) +12 Vdc, 1.0 A max. (100 mA max. - no LAN) -12 Vdc, 100 mA max.
Microprocessor	MC68030
Clock signal	16/25/32 MHz to MPU and FPC (depends on version)
Addressing	
Total address range (on and offboard)	4GB
EPROM/EEPROM	Four sockets, 32 pin, for 8K x 8 to 1M x 8 devices
Dynamic RAM	4/8/16/32MB (depends on version)
I/O ports	
Serial	Four multiprotocol serial ports (connected through P2 to transition module)
Parallel	Parallel I/O Centronics printer port (connected through P2 to transition module)
Timers	Four total
Time-of-day clock	Mostek MK48T02
Watchdog timer	16-bit (tick timer output is watchdog timer input)
Tick timers	Two 16-bit programmable

Table 1-2. MVME147S Specifications (Continued)

Characteristics	Specifications
Bus configuration	Data transfer bus master, with 32-bit address (A32) and 32-bit data (D32) (A24:D16 also supported)
Interrupt handler	Any or all onboard, plus up to seven VMEbus interrupts
Bus arbitration	Two modes: prioritized mode and rotating priority mode
Reset	RESET switch which can be enabled/disabled by software. If the MVME147S is the system controller, it also activates SYSRESET* (system reset) on the VMEbus.
Operating temperature	0 degrees to 55 degrees C at point of entry of forced air (approximately 490 LFM)
Storage temperature	-40° to 85° C
Relative humidity	-5% to 90% (noncondensing)
Physical characteristics (excluding front panel)	
Height	9.187 inches (233.35 mm)
Depth	6.299 inches (160.0 mm)
Thickness	0.063 inches (1.6 mm)

Cooling Requirements

Motorola VMEmodules are specified, designed, and tested to operate reliably with an incoming air temperature range from 0 degrees C to 55 degrees C (32 degrees F to 131 degrees F) with forced air cooling. Temperature qualification is performed in a standard Motorola VMEsystem 1000 chassis. Twenty-five watt load boards are inserted in the two card slots, one on each side, adjacent to the board under test to simulate a high power density system configuration. An assembly of three

axial fans, rated at 100 CFM per fan, is placed directly under the MVME card cage. The incoming air temperature is measured between the fan assembly and the card cage where the incoming airstream first encounters the module under test. Test software is executed as the module is subjected to ambient temperature variations. Case temperatures of critical, high power density integrated circuits are monitored to ensure component vendors specifications are not exceeded.

While the exact amount of airflow required for cooling depends on the ambient air temperature and the type, number, and location of boards and other heat sources, adequate cooling can usually be achieved with 10 CFM flowing over the module. Less air flow is required to cool the module in environments having lower maximum ambients. Under more favorable thermal conditions it may be possible to operate the module reliably at higher than 55 degrees C with increased air flow. It is important to note that there are several factors, in addition to the rated CFM of the air mover, which determine the actual volume of air flowing over a module.

FCC Compliance

These VMEmodules (MVME147S) were tested in an FCC-compliant chassis, and meet the requirements for Class A equipment. FCC compliance was achieved under the following conditions:

- ❑ Shielded cables on all external I/O ports
- ❑ Cable shields connected to earth ground via metal shell connectors bonded to a conductive module front panel
- ❑ Conductive chassis rails connected to earth ground
- ❑ Front panel screws properly tightened

For minimum RF emissions, it is essential that the conditions above be implemented; failure to do so could compromise the FCC compliance of the equipment containing the modules.

General Description

The MVME147S is a double-high VME module and is best utilized in a 32-bit VMEbus system with both P1 and P2 backplanes. The module has high functionality with large onboard shared RAM, serial ports, and Centronics printer port. The module provides a SCSI bus controller with DMA, floating-point coprocessor, tick timer, watchdog timer, and time-of-day clock/calendar with battery backup, 2KB of static RAM with battery backup, four ROM sockets, and A32/D32 VMEbus interface with system controller functions are also provided.

The MVME147S can be operated as part of a VMEbus system with other VME modules such as RAM modules, CPU modules, graphics modules, and analog I/O modules.

Motorola Computer Group Documents

The Motorola publications listed below are referenced in this manual. You can obtain paper or electronic copies of Motorola Computer Group publications by:

- ❑ Contacting your local Motorola sales office
- ❑ Visiting Motorola Computer Group's World Wide Web literature site, <http://www.motorola.com/computer/literature>

Document Title	Publication Number
MVME147Bug Debugging Package User's Manual	MVME147BUG
MVME147 SCSI Firmware User's Manual	MVME147FW
MC68881/MC68882 Floating-Point Coprocessor User's Manual	MC68881UM
MC68030 Enhanced 32-Bit Microprocessor User's Manual	MC68030UM

Document Title	Publication Number
M68000 16/32-Bit Microprocessor Programmer's Reference Manual	M68000UM
MVME147S MPU VMEmodule Support Information	SIMVME147S
MVME712A/MVME712AMMVME712B Transition Module and MVME127P2 Adapter Board User's Manual	MVME712A
MVME712M Transition Module and MVME147P2 Adapter Board User's Manual	MVME712M

To obtain the most up-to-date product information in PDF or HTML format, visit <http://www.motorola.com/computer/literature>.

Related Specifications

For additional information, refer to the following table for related specifications. As an additional help, a source for the listed document is provided. Please note that, while these sources have been verified, the information is subject to change without notice.

ANSI/IEEE Std. 1014-1987 Versatile Backplane Bus: The Institute of Electrical and Electronics Engineers, Inc., 345 East 47th Street, New York, NY 10017, USA. (VMEbus Specification), <http://standards.ieee.org>

Zilog Component Data Book/Z8530A SCC Serial Communications Controller Data Sheet; Zilog, Inc., Corporate Communications, Building A, 1315 Dell Ave, Campbell, CA 95008, <http://www.zilog.com>

SCSI Small Computer System Interface; draft X3T9.2/82-2 - Revision 14; Computer and Business Equipment Manufacturers Association, 311 First Street, N. W., Suite 500, Washington D.C. 20001

MK48T02 2K x 8 ZEROPOWER/TIMEKEEPER RAM Data Sheet; Thompson Components- Mostek Corporation, 1310 Electronics Drive, Carrollton, TX 75006

WD33C93 SCSI-Bus Interface Controller; WESTERN DIGITAL Corporation, 2445 McCabe Way, Irvine, CA 92714, <http://www.wdc.com>

Local Area Network Controller Am7990 (LANCE), Technical Manual, order number 06363A, Advanced Micro Devices, Inc., One AMD Place, P.O. Box 3453, Sunnyvale, CA 94088. <http://www.amd.com>

Manual Terminology

Throughout this manual, a convention has been maintained whereby data and address parameters are preceded by a character which specifies the numeric format as follows:

\$	dollar	specifies a hexadecimal number
%	percent	specifies a binary number
&	ampersand	specifies a decimal number

Unless otherwise specified, all address references are in hexadecimal throughout this manual.

An asterisk (*) following the signal name for signals which are level significant denotes that the signal is true or valid when the signal is low.

An asterisk (*) following the signal name for signals which are edge significant denotes that the actions initiated by that signal occur on high to low transition.

In this manual, assertion and negation are used to specify forcing a signal to a particular state. In particular, assertion and assert refer to a signal that is active or true; negation and negate indicate a signal that is inactive or false. These terms are used independently of the voltage level (high or low) that they represent.

Hardware Preparation and Installation

2

Introduction

This chapter provides the unpacking, hardware preparation, and installation instructions for the MVME147S module. The MVME712A/MVME712AM and MVME712M transition module hardware preparation is provided in separate manuals.

Unpacking Instructions

Note If the carton is damaged upon receipt, request carrier's agent be present during unpacking/ inspection of equipment.

Unpack equipment from shipping carton. Refer to packing list and verify that all items are present. Save packing material for storing and reshipping of the module.



Caution

Avoid touching areas of integrated circuitry; static discharge can damage circuits.

Preparation

To select the desired configuration and ensure proper operation of the MVME147S module, certain changes may be made before installation. These changes are made through jumper arrangements on the headers. The location of the headers, switches, LEDs, and connectors is illustrated in [Figure 2-1](#). The module has been factory tested and is shipped with factory-installed jumper configurations that are shown in the following paragraphs with each header description. The module is operational with the factory-installed jumpers. The module is configured to provide the system functions required for a VMEbus system. It is necessary to make changes in the jumper arrangements for the following conditions:

- ❑ ROM configuration select (J1, J2)
- ❑ System controller select (J3)
- ❑ Factory use only (J5, J6)
- ❑ Serial port 4 clock configuration select (J8, J9)

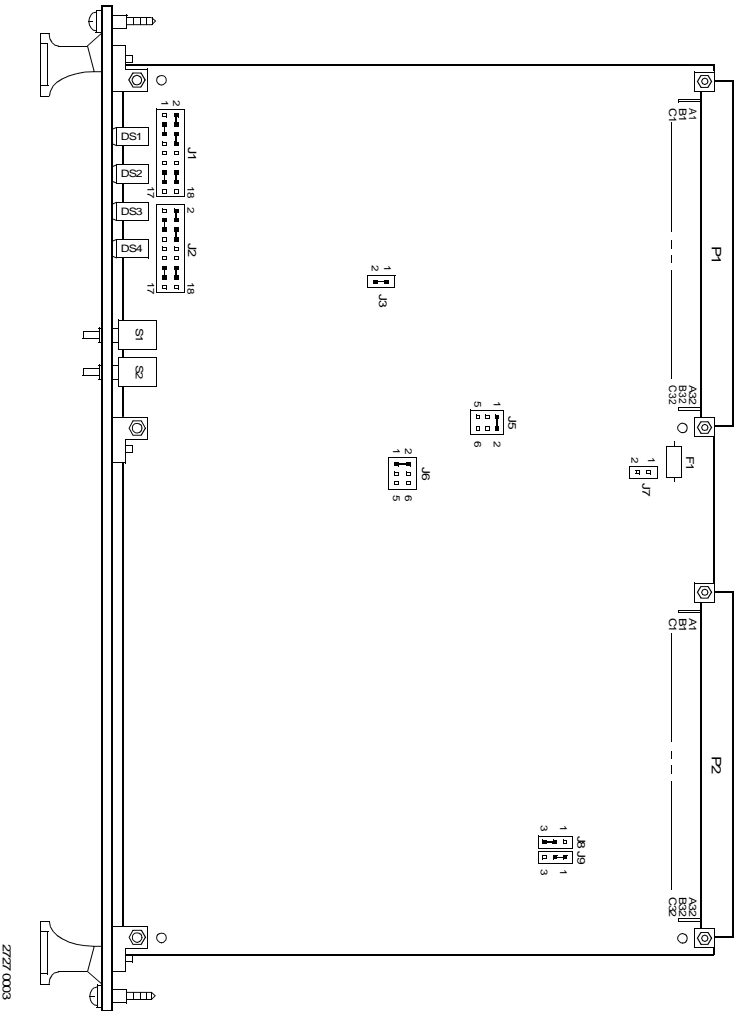
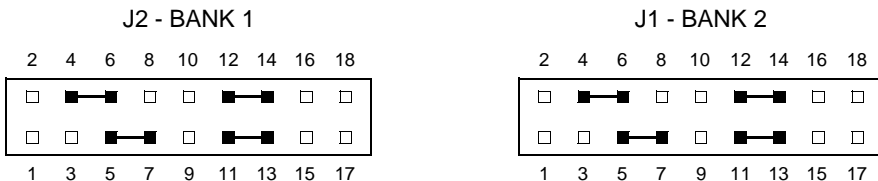

Figure 2-1. MVME147S Header Locations

2 ROM Configuration Select Headers (J1, J2)

The MVME147S supports various sizes of EPROMs and EEPROMs. The module must be configured for the device type used, as shown below. Each pair of sockets may be individually configured. Four 32-pin ROM/PROM/EPROM/ EEPROM sockets are provided on the module. They are organized as two banks with two sockets per bank. Sockets U22 and U30 form bank 1. Sockets U1 and U15 form bank 2. The banks are configured as word ports to the MPU with U22 and U1 comprising the even bytes and U30 and U15 the odd bytes. Each bank can be configured for 8K x 8, 16K x 8, 32K x 8, 64K x 8, 128K x 8, 256K x 8, 512K x 8, or 1M x 8 ROM/PROM/EPROM devices or for 2K x 8, 8K x 8, or 32K x 8 EEPROM devices.

There are several different algorithms for erasing/writing to EEPROM devices depending on the manufacturer. The MVME147S supports only those devices which have a "static RAM" compatible erase/write mechanism such as Xicor X28256 or X2864H.



8K x 8 or 16K x 8 ROM/PROM/EPROM

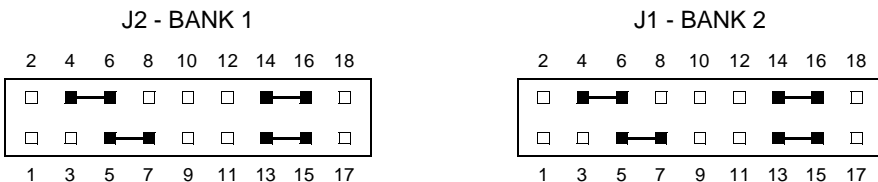

32K x 8 ROM/PROM/EPROM

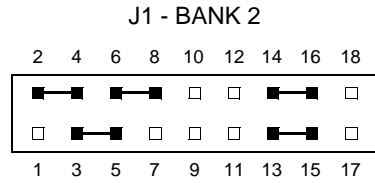
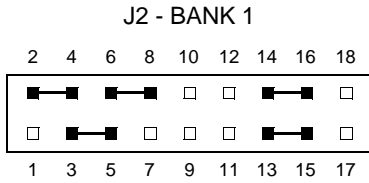

128K x 8 ROM/PROM/EPROM

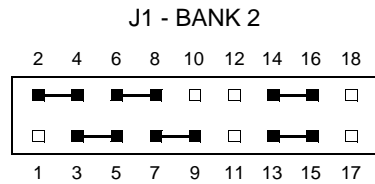
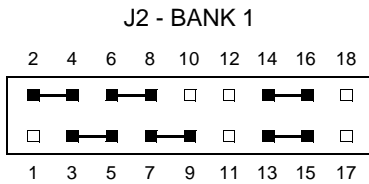

256K x 8 ROM/PROM/EPROM

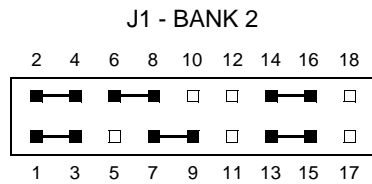
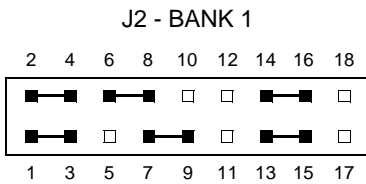

512K x 8 ROM/PROM/EPROM

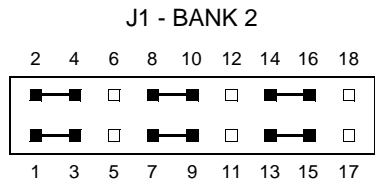
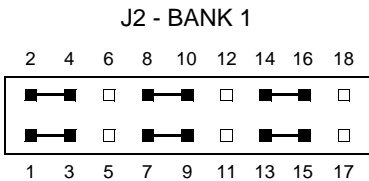

1M x 8 ROM/PROM/EPROM

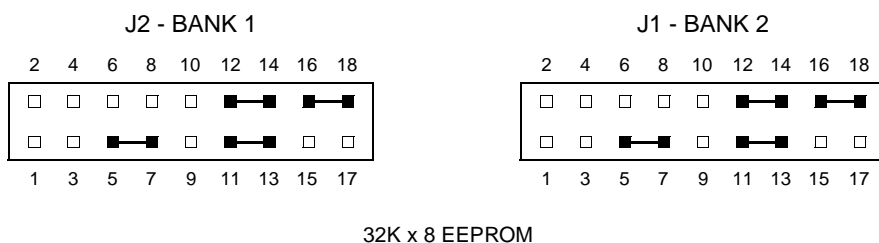
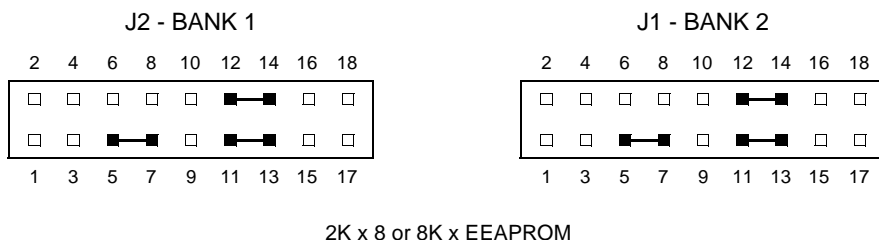

The following figures show the definitions of the ROM/PROM/EPROM/EEPROM socket pins, depending upon the configuration used. The address lines shown are device address lines not local bus address lines. Devices with 28 pins are installed with pin 1 of the device aligned with pin 3 of the socket as shown in the figures below. The configurations shown in the figures are as follows:

Configuration Number	Device Type
1	8K x 8, 16K x 8 EPROM
2	32K x 8 EPROM
3	64K x 8 EPROM
4	2K x 8 (28-pin) 8K x 8 EEPROM
5	128K x 8 EPROM
6	256K x 8 EPROM

- 7 512K x 8 EPROM
- 8 1M x 8 EPROM
- 9 32K x 8 EEPROM

The sockets are installed on the module with pins oriented as shown below:

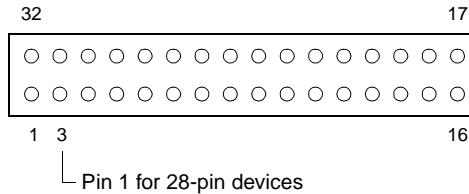

CONFIGURATION				CONFIGURATION					
1	2	3	4			4	3	2	1
				1	32	+5V	+5V	+5V	+5V
A17	A17	A17	A17	2	31				
+5V	+5V	A16		3	1 28 30	+5V	+5V	+5V	+5V
A13	A13	A13	A13	4	2 27 29	WE*	A15	A15	WE*
A8	A8	A8	A8	5	3 26 28	A14	A14	A14	A14
A7	A7	A7	A7	6	4 25 27	A9	A9	A9	A9
A6	A6	A6	A6	7	5 24 26	A10	A10	A10	A10
A5	A5	A5	A5	8	6 23 25	A12	A12	A12	A12
A4	A4	A4	A4	9	7 22 24	OE*	OE*	OE*	OE*
A3	A3	A3	A3	10	8 21 23	A11	A11	A11	A11
A2	A2	A2	A2	11	9 20 22	CE*	CE*	CE*	CE*
A1	A1	A1	A1	12	10 19 21	D7	D7	D7	D7
D0	D0	D0	D0	13	11 18 20	D6	D6	D6	D6
D1	D1	D1	D1	14	12 17 19	D5	D5	D5	D5
D2	D2	D2	D2	15	13 16 18	D4	D4	D4	D4
GND	GND	GND	GND	16	14 15 17	D3	D3	D3	D3

CONFIGURATION				CONFIGURATION								
5	6	7	8					8	7	6	5	
+5V	+5V	+5V	A20	1				32	+5V	+5V	+5V	+5V
A17	A17	A17	A17	2				31	A19	A19	+5V	+5V
A16	A16	A16	A16	3	1	28	30		A18	A18	A18	A18
A13	A13	A13	A13	4	2	27	29		A15	A15	A15	A15
A8	A8	A8	A8	5	3	26	28		A14	A14	A14	A14
A7	A7	A7	A7	6	4	25	27		A9	A9	A9	A9
A6	A6	A6	A6	7	5	24	26		A10	A10	A10	A10
A5	A5	A5	A5	8	6	23	25		A12	A12	A12	A12
A4	A4	A4	A4	9	7	22	24		OE*	OE*	OE*	OE*
A3	A3	A3	A3	10	8	21	23		A11	A11	A11	A11
A2	A2	A2	A2	11	9	20	22		CE*	CE*	CE*	CE*
A1	A1	A1	A1	12	10	19	21		D7	D7	D7	D7
D0	D0	D0	D0	13	11	18	20		D6	D6	D6	D6
D1	D1	D1	D1	14	12	17	19		D5	D5	D5	D5
D2	D2	D2	D2	15	13	16	18		D4	D4	D4	D4
GND	GND	GND	GND	16	14	15	17		D3	D3	D3	D3

Configuration 9

Configuration 9

	1				32	
	2				31	
A15	3	1	28	30		+5V
A13	4	2	27	29		WE*
A8	5	3	26	28		A14
A7	6	4	25	27		A9
A6	7	5	24	26		A10
A5	8	6	23	25		A12
A4	9	7	22	24		OE*
A3	10	8	21	23		A11

Configuration 9		Configuration 9	
A2	11 9 20 22	CE*	
A1	12 10 19 21	D7	
D0	13 11 18 20	D6	
D1	14 12 17 19	D5	
D2	15 13 16 18	D4	
GND	16 14 15 17	D3	

System Controller Select Header (J3)

Header J3 allows the user to select the MVME147S as system controller. With the jumper removed, the module is not used as system controller. The module is shipped with the jumper installed (system controller).

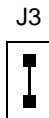

SYSTEM CONTROLLER

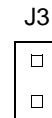

NOT SYSTEM CONTROLLER

Factory Use Only Headers (J5, J6)

Headers J5 and J6 are for factory use only and have no user value. The factory configurations should not be altered. Header J6 is shown below for information only.

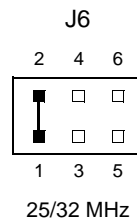

Serial Port 4 Clock Configuration Select Headers (J8, J9)

Serial port 4 can be configured to use clock signals provided by the TRXC4 and RTXC4 signal lines. Headers J8 and J9 on the MVME147S module configure part of the clock signals. The remaining configuration of the clock lines is accomplished using header J15 on the MVME712M module. Refer to the *MVME712 Transition Module and MVME147P2 Board User's Manual* for header J15 configuration.

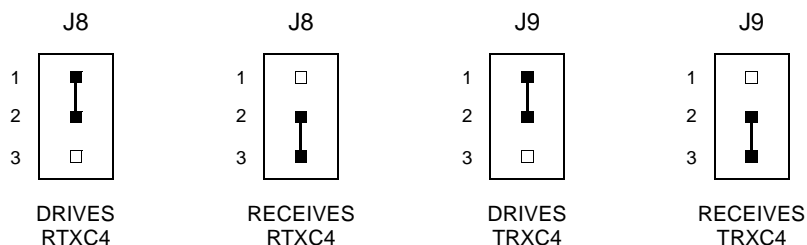

Installation Instructions

When the MVME147S has been configured as desired by the user, it can be installed in the system as follows:

1. Turn all equipment power OFF and disconnect power cable from AC power source.



Caution

Connecting modules while power is applied may result in damage to components on the module.



Warning

Dangerous voltages, capable of causing death are present in this equipment. Use extreme caution when handling, testing, and adjusting.

2. Remove chassis cover as instructed in the equipment user's manual.

3. Remove the filler panel(s) from the appropriate card slot(s) at the front and rear of the chassis (if the chassis has a rear card cage). If the MVME147S is configured as the system controller, it must be installed in the left most card slot (slot 1) to correctly initiate the bus grant daisy-chain. The MVME147S is to be installed in the front of the chassis and the MVME712A/MVME712AM/MVME712B/MVME712M may be installed in the front or rear of the chassis.

Every MVME147S is assigned an Ethernet station address. The address is \$08003E2XXXXX where XXXXX is the unique number assigned to the module (every MVME147S has a different value for XXXXX).

Each Ethernet station address is displayed on a label attached to the back of the MVME147S front panel. In addition, the XXXXX portion of the Ethernet station address is stored in BBRAM, location \$FFFE0778 as \$2XXXXX.

If Motorola networking software is running on an MVME147S, it uses the 2XXXXX value from BBRAM to complete the Ethernet station address (\$08003E2XXXXX). The user must assure that the value of 2XXXXX is maintained in BBRAM. If the value of 2XXXXX is lost in BBRAM, the user should use the number on the front panel label to restore it. Note that MVME147Sbug includes the "LSAD" command for examining and updating the BBRAM XXXXX value.

If nonMotorola networking software is running on an MVME147S, it must set up the 7990 so that the Ethernet station address is that shown on the front panel label to ensure that the module has a globally unique Ethernet station address.

4. Insert the MVME147S into the selected card slot. Be sure the module is seated properly into the connectors on the backplane. Fasten the module in the chassis with the screws provided. For proper operation, a 32-bit VMEbus backplane should be used. This insures that power is sufficiently distributed over enough power pins on connectors P1 and P2.

5. Remove IACK and BG jumpers from header on chassis backplane for the card slot in which the MVME147S is installed (if applicable).
6. Install MVME712A module according to installation instructions in the *MVME712M Transition Module and MVME147P2 Adapter Board User's Manual*.
7. Turn equipment power ON.

The MVME147S provides +12 Vdc power to the Ethernet transceiver interface through a 1 amp fuse (F1) located on the MVME147S module. The fuse is socketed and located near P1. If the Ethernet transceiver fails to operate, check the fuse. When using the MVME712M module, the yellow LED (DS1) on the MVME712M front panel, lights when LAN power is available, indicating that the fuse is good. Note that the yellow LED may light if any one of the four serial ports is connected on the MVME712M regardless of the state of F1.

The MVME147S provides SCSI terminator power through a 1 amp fuse (F1) located on the P2 adapter board. The fuse is socketed. If the fuse is blown, the SCSI devices may not operate or may function erratically. When the P2 adapter is used with an MVME712M and the SCSI bus is connected to the MVME712M, the green LED (DS2) lights when there is SCSI terminator power. If the LED flickers during SCSI bus operations, the fuse should be checked.

Introduction

This chapter provides the necessary information to use the MVME147S module in a system configuration.

Controls and Indicators

The MVME147S module has RESET and ABORT switches, and RUN, STATUS, FAIL, and SCON indicators, all of which are located on the front panel of the module. A summary of front panel indicators and status is listed in [Table 3-1](#).

RESET Switch S2

A front panel RESET switch S2 (if enabled) generates a local reset and (if system controller) also generates a VMEbus system reset.

If the MVME147S is not the system controller, this switch should not be used if the local MPU is executing VMEbus cycles.

The Peripheral Channel Controller (PCC) provides the RESET switch interface. The RESET switch signal is debounced and when it is enabled, it causes a reset out signal. The RESET switch can be enabled/disabled by software.

Remote Reset Switch Connector (J4)

Connector J4 allows the front panel reset function to be provided remotely by a user-supplied/installed switch/cable assembly. Shorting the two pins has the same effect as pressing the front panel RESET switch.

When the remote switch and cable are installed, the MVME147S can be reset by either the remote switch or by the front panel switch.

ABORT Switch S1

A software ABORT switch S1 is located on the front panel. The ABORT switch is normally used to abort program execution and return to the debugger.

The PCC provides the ABORT switch interface. The ABORT switch signal is debounced and sent to the level 7 interrupter. When enabled, the ABORT causes a Level 7 interrupt to the MC68030. The interrupter returns a status/ID vector when requested. The ABORT switch can be enabled/disabled by software.

FAIL Indicator (DS1)

The red LED FAIL indicator (DS1), located on the front panel, indicates the status of the BRDFAIL bit in the VMEchip. The FAIL LED is lit when the BRDFAIL bit is set or when watchdog time-out occurs in the PCC. Also, if the FAIL LED is lit and SYSFAIL inhibit bit in the VMEchip is not set, the MVME147S drives SYSFAIL on the VMEbus.

STATUS Indicator (DS2)

The yellow LED STATUS indicator (DS2), located on the front panel, is lit whenever the MC68030 STATUS* pin is low. When the yellow LED is fully lit, the processor has halted.

RUN Indicator (DS3)

The green LED RUN indicator (DS3), located on the front panel, is connected to the MC68030 address strobe (AS*) signal and indicates that the MPU is executing a bus cycle.

SCON Indicator (DS4)

The green LED SCON indicator (DS4), located on the front panel, is lit when the MVME147S is the VMEbus system controller.

Table 3-1. Front Panel LEDs and MVME147S Status

FAIL	STATUS	RUN	MVME147S Status
DS1	DS2	DS3	
Red	Yellow	Green	
off	off	off	No power is applied to the module, or the MPU is not the current local bus master.
off	off	ON	MPU is waiting for a cycle to complete.
off	ON	off	MPU is halted.
	(bright)		
off	ON	off	MPU is executing out of its onchip cache only.
	(normal)		
off	ON	ON	Normal operation.
ON	off	off	MPU is not current local bus master and is not executing out of onchip cache. Also, [BRDFAIL] has not been cleared since reset or has been set by software.
ON	off	ON	[BRDFAIL] has not been cleared since reset or has been set by software. Also, MPU is waiting for a cycle to complete.
ON	ON	off	
	(bright)		
			MPU is halted and [BRDFAIL] has not been cleared since reset or has been set by software.
ON	ON	off	
	(normal)		
			[BRDFAIL] has not been cleared since reset or has been set by software. Also, MPU is executing out of onchip cache only.
ON	ON	ON	[BRDFAIL] has not been cleared since reset or software set [BRDFAIL].

Memory Maps

There are two points of view or memory maps on the MVME147S: the mapping of all resources as viewed by the MC68030 (the MC68030 memory map), and the mapping of MVME147S resources as viewed by VMEbus masters (VMEbus memory map). (The MVME712 transition module has no memory-mapped devices.)

MC68030 Memory Map

The MC68030 memory map is split into different address spaces by the function codes. The MVME147S has different groups of devices that respond depending on the address space as shown in [Table 3-2](#).

Table 3-2. MVME147S Address Spaces

FC (2-0)	Address Space	MVME147S Devices that Respond
0	Reserved	None (causes local time-out)
1	User data	All except interrupt handler and MC68882
2	User program	All except interrupt handler and MC68882
3	Reserved	None (causes local time-out)
4	Reserved	None (causes local time-out)
5	Supervisor data	All except interrupt handler and MC68882
6	Supervisor program	All except interrupt handler and MC68882
7	CPU (IACK)	Interrupt handler
7	CPU (coproc)	MC68882

Program and Data Address Spaces

The memory map of devices that respond in user data, user program, supervisor data, and super prog spaces is shown in the following tables. The entire map from \$00000000 to \$FFFFFFF is shown in the next table. The I/O devices are further defined in [Table 3-4](#).

Table 3-3. MC68030 Main Memory Map

Address Range	Devices Accessed	Port Size	Size	H/W Cache Inhibit	Notes
00000000- DRAMsize	Onboard DRAM	D32	4-32MB	No	1,2
DRAMsize- EFFFFFFF	VMEbus A32/A24	D32	3GB	Yes	3,4
F0000000- F0FFFFFF	VMEbus A24	D16	16MB	Yes	
F1000000- FF7FFFFFF	VMEbus A32	D16	232MB	Yes	
FF800000- FF9FFFFFF	ROM/EEPROM M bank 1	D16	2MB	Yes	
FFA00000- FFBFFFFFF	ROM/EEPROM M bank 2	D16	2MB	Yes	
FFC00000- FFDFFFFFF	Reserved	N/A	4MB	Yes	3
FFFE0000- FFFE4FFF	Local I/O devices	D8/D16/D32	20KB	Yes	
FFFE5000- FFFEFFFF	Reserved	N/A	44KB	Yes	
FFFF0000- FFFFFFF	VMEbus short I/O	D16	64KB	Yes	
Notes:					

Table 3-3. MC68030 Main Memory Map (Continued)

Address Range	Devices Accessed	Port Size	Size	H/W Cache Inhibit	Notes
1.	Onboard ROM/PROM/EPROM/EEPROM bank 1 for first 4 cycles after a reset, onboard DRAM thereafter.				
2.	DRAMsize varies from 4MB to 32MB depending on the specific version of the MVME147S.				
3.	Size is approximate.				
4.	This A24 only applies to VMEbus space that falls below \$01000000. VMEbus space below \$01000000 only occurs on versions of the MVME147S that have DRAMsize smaller than 16MB.				

The local I/O devices portion of the MC68030 main memory map is shown in the following table.

Table 3-4. Local I/O Devices

Address Range	Devices Accessed	Port Size	Size	Notes
FFFE0000-FFFE07F7	BB RAM	D8	2040 bytes	3
FFFE07F8-FFFE07FF	BB TOD clock	D8	8 bytes	3
FFFE0800-FFFE0FFF	BB RAM and TOD clock (repeated)	D8		
FFFE1000-FFFE100F	PCC 32-bit registers	D32	16 bytes	
FFFE1010-FFFE102F	PCC 16-bit registers	D16	32 bytes	
FFFE1030-FFFE17FF	PCC registers (repeated)	D32/D16		
FFFE1800-FFFE1803	LANCE (AM7990)	D16	4 bytes	3,4
FFFE1804-FFFE1FFF	LANCE (repeated)	D16		
FFFE2000-FFFE201F	VMEchip registers	D16	32 bytes	
FFFE2020-FFFE27FF	VMEchip registers (repeated)	D16		
FFFE2800	Printer data (write only)	D8	1 byte	
FFFE2800	Printer status (read only)	D8	1 byte	
FFFE2801-FFFE2FFF	Printer registers (repeated)	D8		
FFFE3000-FFFE3001	Serial 2	D8	2 bytes	1,3
FFFE3002-FFFE3003	Serial 1	D8	2 bytes	1,3

Table 3-4. Local I/O Devices (Continued)

Address Range	Devices Accessed	Port Size	Size	Notes
FFFE3004-FFFE37FF	Serial 2,1 (repeated)	D8		
FFFE3800-FFFE3801	Serial 4	D8	2 bytes	2,3
FFFE3802-FFFE3803	Serial 3	D8	2 bytes	2,3
FFFE3804-FFFE3FFF	Serial 4,3 (repeated)	D8		
FFFE4000-FFFE401F	SCSI registers (WD33C93)	D8	32 bytes	3,5
FFFE4020-FFFE4FFF	SCSI registers (repeated)	D8		5
Notes:				
1.	Serial ports 1 and 2 are sections A and B, respectively, of the first Z8530.			
2.	Serial ports 3 and 4 are sections A and B, respectively, of the second Z8530.			
3.	For a complete description of the register bits, refer to the data sheet for the specific chip.			
4.	The LAN chip is not installed on the MVME147SRF. Access to these addresses results in a local bus time-out.			
5.	The WD33C93 is interfaced in nonmultiplexed mode. Only addresses \$FFFE4000 (address/status register) and \$FFFE4001 (data register) are necessary for operation. All accesses to the WD33C93 go through the PCC.			

CPU Address Space

The MVME147S responds to two types of CPU space cycles: coprocessor and interrupt acknowledge. The MC68030 is capable of generating other types of CPU space cycles (using breakpoint acknowledge, access level control, or MOVES instructions), but the MVME147S has no devices that respond to them.

Coprocessor Register Map

The MC68882 is the only coprocessor on the MVME147S. The map decoder selects the MC68882 any time the MPU executes a coprocessor cycle with Cp-ID of %001 (FC2-FC0 = %111 and A19-A13 = %0010001). The MC68882 registers are selected by A4-A0 as shown in the following table.

Table 3-5. MC68882 Register Map

A4-A0 (in Binary)	MC68881/MC68882 Register	Comments	Port Size
%0000X	Response	Read only	D16
%0001X	Control	Write only	D16
%0010X	Save	Read only	D16
%0011X	Restore	Read/write	D16
%0100X	Reserved		D16
%0101X	Command	Write only	D16
%0110X	Reserved		D16
%0111X	Condition	Write only	D16
%100XX	Operand	Read/write	D32
%1010X	Register select	Read only	D16
%1011X	Reserved		D16
%110XX	Instruction address	Read/write	D32
%111XX	Operand address	Read/write	D32
Note:	Writes to the MC68882 read only registers are ignored and reads to write only registers return all 1's. If the MC68882 is not present on the MVME147S, then accesses to it result in an F line exception.		

Interrupt Acknowledge Map

The MC68030 distinguishes interrupt acknowledge cycles from other CPU space cycles by placing the binary value %1111 on A19-A16. It also specifies the level that is being acknowledged using A03-A01. The interrupt handler selects which device within that level is being acknowledged. Refer to *Interrupt Handler Mask Register* in [Chapter 4](#).

VMEbus Memory Map

The following paragraphs describe the mapping of MVME147S resources as viewed by VMEbus masters.

The MVME147S onboard DRAM, VMEchip global registers, and VMEbus interrupter respond to accesses by VMEbus masters. No other devices on the MVME147S respond to such accesses.

VMEbus Accesses to MVME147S Onboard DRAM

When a VMEbus master accesses the MVME147S onboard DRAM, it must do so using the address modifier selected by a control register in the VMEchip and the base address selected by a control register in the PCC. Refer to the following table.

Table 3-6. DRAM Address as Viewed from the VMEbus

					Beginning	Ending	
RBA4	RBA3	RBA2	RBA1	RBA0	Address	Address	Notes
0	0	0	0	0	\$00000000	(1 x DRAMsize)-1	
0	0	0	0	1	1 x DRAMsize	(2 x DRAMsize)-1	1,2
0	0	0	1	0	2 x DRAMsize	(3 x DRAMsize)-1	1,2
0	0	0	1	1	3 x DRAMsize	(4 x DRAMsize)-1	1,2
0	0	1	0	0	4 x DRAMsize	(5 x DRAMsize)-1	1,2
0	0	1	0	1	5 x DRAMsize	(6 x DRAMsize)-1	1,2
0	0	1	1	0	6 x DRAMsize	(7 x DRAMsize)-1	1,2
0	0	1	1	1	7 x DRAMsize	(8 x DRAMsize)-1	1,2
0	1	0	0	0	8 x DRAMsize	(9 x DRAMsize)-1	1,2
0	1	0	0	1	9 x DRAMsize	(10 x DRAMsize)-1	1,2
0	1	0	1	0	10 x DRAMsize	(11 x DRAMsize)-1	1,2
0	1	0	1	1	11 x DRAMsize	(12 x DRAMsize)-1	1,2
0	1	1	0	0	12 x DRAMsize	(13 x DRAMsize)-1	1,2
0	1	1	0	1	13 x DRAMsize	(14 x DRAMsize)-1	1,2
0	1	1	1	0	14 x DRAMsize	(15 x DRAMsize)-1	1,2

Table 3-6. DRAM Address as Viewed from the VMEbus (Continued)

					Beginning	Ending	
RBA4	RBA3	RBA2	RBA1	RBA0	Address	Address	Notes
0	1	1	1	1	15 x DRAMsize	(16 x DRAMsize)-1	1,2
1	0	0	0	0	16 x DRAMsize	(17 x DRAMsize)-1	1,2
1	0	0	0	1	17 x DRAMsize	(18 x DRAMsize)-1	1,2
1	0	0	1	0	18 x DRAMsize	(19 x DRAMsize)-1	1,2
1	0	0	1	1	19 x DRAMsize	(20 x DRAMsize)-1	1,2
1	0	1	0	0	20 x DRAMsize	(21 x DRAMsize)-1	1,2
1	0	1	0	1	21 x DRAMsize	(22 x DRAMsize)-1	1,2
1	0	1	1	0	22 x DRAMsize	(23 x DRAMsize)-1	1,2
1	0	1	1	1	23 x DRAMsize	(24 x DRAMsize)-1	1,2
1	1	0	0	0	24 x DRAMsize	(25 x DRAMsize)-1	1,2
1	1	0	0	1	25 x DRAMsize	(26 x DRAMsize)-1	1,2
1	1	0	1	0	26 x DRAMsize	(27 x DRAMsize)-1	1,2
1	1	0	1	1	27 x DRAMsize	(28 x DRAMsize)-1	1,2
1	1	1	0	0	\$0000000	(1 x DRAMsize)-1	1,3,4
1	1	1	0	1	1 x DRAMsize	(2 x DRAMsize)-1	1,3,4
Notes:							
1.	DRAMsize = the size of the DRAM. For example, if the 4MB version is used, then DRAMsize = \$400000, and (3 x DRAMsize)-1 = \$BFFFFF.						
2.	When beginning address is less than 16MB, the DRAM responds to standard or extended address modifiers. When beginning address is 16MB or greater, the DRAM responds to extended address modifiers only. Note that bits 4 and 5 in the VMEchip Slave Address Modifier Register further control response to standard and extended address modifiers.						
3.	This combination pertains only to DRAMsize of 16MB or 32MB.						
4.	The values shown in the table refer to extended addresses only. In the standard address range the DRAM responds to \$000000 through \$7FFFFFFF.						

VMEbus Short I/O Memory Map

The VMEchip Global Control and Status Register (GCSR) Set appears at odd addresses in the VMEbus short I/O memory map. A map decoder in the VMEchip monitors the address and the address modifier lines and requests the VMEchip global registers when they are selected. Note that the GCSR can only be accessed in Supervisor Data Space; no User Mode accesses are available.

The VMEchip GCSR base address is selected using a control register (GCSR base address configuration register) in the VMEchip Local Control and Status Register (LCSR) as shown in the next table. A MVME147S may access its own VMEchip GCSR via the VMEbus.

The MVME147S (and the MVME147BUG default) powers up with the GCSR base address programmed with \$F. This is intentionally done so that the GCSR set is not mapped on the VMEbus.

Table 3-7. VMEchip GCSR as Viewed from the VMEbus

LCSR Register Bits	Short I/O Address of GCSR
\$0	\$0000-000F
\$1	\$0010-001F
\$2	\$0020-002F
\$3	\$0030-003F
\$4	\$0040-004F
\$5	\$0050-005F
\$6	\$0060-006F
\$7	\$0070-007F
\$8	\$0080-008F
\$9	\$0090-009F
\$A	\$00A0-00AF
\$B	\$00B0-00BF

Table 3-7. VMEchip GCSR as Viewed from the VMEbus

LCSR Register Bits	Short I/O Address of GCSR
\$C	\$00C0-00CF
\$D	\$00D0-00DF
\$E	\$00E0-00EF
\$F	Does not respond

VMEbus Interrupt Acknowledge Map

The VMEbus distinguishes interrupt acknowledge cycles from other cycles by activating the IACK* signal line. It also specifies the level that is being acknowledged using A03-A01. The VMEchip monitors these lines and after receiving IACKIN*, it responds by asserting IACKOUT* if it was not generating an interrupt at the acknowledged level, or by returning a status/ID vector if it was. The MVME147S may handle a VMEbus interrupt generated by its own VMEchip.

Introduction

This chapter provides the information needed to program the Peripheral Channel Controller (PCC) and the VMEchip.

Programming The Peripheral Channel Controller

These sections contain a description of the PCC internal registers and the bit assignments within each register. All registers may be written or read as bytes. Some restrictions apply to bit set and clear instructions and they should not be used, where indicated. An overall view of the PCC is shown in [Table 4-1](#).

Table Address Register

This 32-bit read/write register points to a table of physical addresses and byte counts that are used during DMA transfers when table mode is selected. The table address must be longword aligned because bits 0 and 1 are always zero. If the table address has bit 0 or 1 set, they are truncated and no error is generated. These bits are not affected by reset. Refer to Chapter 5 for details on Table Address.

FFFE1000	Table Address	0	0
----------	---------------	---	---

Data Address Register

This 32-bit read/write register points to the physical address where data is to be transferred. Data can only be transferred to/from onboard DRAM or VMEbus memory. These bits are not affected by reset.

FFFE1004	Data Address
----------	--------------

32-Bit Registers

Table 4-1. PCC Overall View

Address	Register	Function
FFFE1000	Table Address (bits 1 and 0 are zeroes)	DMA
FFFE1004	Data Address	DMA
FFFE1008	Link 0000 DFC2-0 Byte count (24 bits)	DMA
FFFE100C	Data holding register	DMA

16-Bit Registers

Address	Register	Function
FFFE1010	Timer 1 preload	Timer 1
FFFE1012	Timer 1 count	Timer 1
FFFE1014	Timer 2 preload	Timer 2
FFFE1016	Timer 2 count	Timer 2

8-Bit Registers

Address	Bit 7	Bit 6	Bit 5	Bit 4	Bit 3	Bit 2	Bit 1	Bit 0	Function
FFFE1018	T1ISt				T1IEn	T1IL2	T1IL1	T1IL0	Timer 1
FFFE1019	T1Ovf3	T1Ovf2	T1Ovf1	T1Ovf0		T1OvfCLR	T1CntEn	T1En	Timer 1
FFFE101A	T2ISt				T2IEn	T2IL2	T2IL1	T2IL0	Timer 2
FFFE101B	T2Ovf3	T2Ovf2	T2Ovf1	T2Ovf0		T2OvfClr	T2CntEn	T2En	Timer 2
FFFE101C	AcfISt	AcfISt			AcfIEn				ACFAIL
FFFE101D	WdL3	WdL2	WdL1	WdL0	WdTO	WdRst	WdClr	WdEn	Watchdog
FFFE101E	PrISt	PrFltI	PrAckI	PrAckP	PrEn	PrIL2	PrIL1	PrIL0	Printer
FFFE101F					PrnP	PrStb	PrStbT	PrMode	Printer
FFFE1020	DMAISt				DMAIEn	DMAIL2	DMAIL1	DMAIL0	DMA
FFFE1021	DMADn	DMA8Er	TWSzEr	DMABEr	TWBEr	MS/SM*	TW	DMAEn	DMA
FFFE1022	BErrISt				BErrIEn				BERR Int
FFFE1023	DMAInc4	DMAInc3	DMAInc2	DMAInc1	HRStUU	HRStUM	HRStLM	HRStLL	DMA

Address	Bit 7	Bit 6	Bit 5	Bit 4	Bit 3	Bit 2	Bit 1	Bit 0	Function
FFFE1024	AbtSt	AbtSt			AbtEn				ABORT
FFFE1025						TblFC2	TblFC1	TblFC0	DMA
FFFE1026	SerSt			I/E*	SerEn	SerIL2	SerIL1	SerIL0	Serial
FFFE1027	RSDis2	RSDis1	RSDis0	MIntEn	LBTO	WWPar	ParEn1	ParEn0	Control
FFFE1028	LANISt				LANIEn	LANIL2	LANIL1	LANIL0	LANCE
FFFE1029							PURst	ParErr	Status
FFFE102A	ScISt	ScRstE	ScRstL	ScRstO	ScIEn	ScIL2	ScIL1	ScIL0	SCSI
FFFE102B	LANA25	LANA24	WAIT RMC	RBA4	RBA3	RBA2	RBA1	RBA0	RAM base
FFFE102C	Sw1ISt				Sw1IEn	Sw1IL2	Sw1IL1	Sw1IL0	Soft Int1
FFFE102D	IVB7	IVB6	IVB5	IVB4					IntVbase
FFFE102E	Sw2ISt				Sw2IEn	Sw2IL2	Sw2IL1	Sw2IL0	Soft Int2
FFFE102F	RevL7	RevL6	RevL5	RevL4	RevL3	RevL2	RevL1	RevL0	Chip rev
FFFE2800	PrD7	PrD6	PrD5	PrD4	PrD3	PrD2	PrD1	PrD0	Printer
FFFE2800	PrAck	PrFlt	PrSel	PrPE	PrBsy	BREV1	BREV0	STAT 12	Printer

Byte Count Register

This 32-bit read/write register contains a 24-bit byte counter in bits 0-23, a 3-bit function code in bits 24-26 and a link bit in bit 31. The byte counter contains the number of bytes to be transferred. The function code bits are used when data is transferred. When set in a table entry, the link bit indicates there are more entries in the DMA table. This bit is cleared in the last table entry. The link bit is only used in table mode and is never set by the MC68030. These bits are not affected by reset.

ADDRESS	BIT 31	BIT 30	BIT 29	BIT 28	BIT 27	BIT 26	BIT 25	BIT 24	BITS 23-0
FFFE1008	L	0	0	0	0	DFC2	DFC1	DFC0	Byte count

Data Holding Register

This read only register holds data passing between the SCSI and local buses. These bits are not affected by reset.

FFFE100C	Data Holding Register
----------	-----------------------

Timer 1 Preload Register

This 16-bit read/write register holds the tick timer preload value. When the counter reaches \$FFFF, it is loaded with this value and if interrupts are enabled, an interrupt is generated. When running, the counter is incremented every 6.25 μ s. The equation below should be used to determine the counter value (n) for a periodic interrupt of time t where t is in seconds.

FFFE1010	Tick 1 preload
----------	----------------

$$n = 65536 - \frac{t}{6.25 \times 10^{-6}}$$

The timer may be programmed to generate interrupts at intervals between 6.25 μ s and .4096 seconds. These bits are not affected by reset.

Timer 1 Counter Register

This 16-bit read register is the output of the tick counter. Reads are not synchronized with counter updates.

FFFE1012	Tick 1 counter
----------	----------------

Timer 2 Preload Register

This 16-bit read/write register holds the tick timer preload value. Refer to the *Tick 1 Preload Register* section in this chapter.

Timer 2 Counter Register

This 16-bit read register is the output of the tick counter. Reads are not synchronized with counter updates.

FFFE1016	Tick 2 counter
----------	----------------

Timer 1 Interrupt Control Register

The table below shows the timer 1 interrupt control register.

Address	Bit7	Bit6	Bit5	Bit4	Bit 3	Bit 2	Bit 1	Bit 0
FFFE1018	Int stat				Enable	IL2	IL1	IL0
	R/C				R/W	R/W	R/W	R/W

4

Note Bit set and clear instructions should not be used on this interrupt control register. Because an interrupt is cleared by writing a one to the status bit and the status bit is a one to indicate a pending interrupt, the read-modify-write sequence may clear a pending interrupt.

Bits 0-2 These bits program the interrupt level the tick timer generates. Because level 0 does not generate an interrupt, this level is intended for polling software. These bits are cleared by reset.

Bit 3 When this bit is high, the interrupt is enabled. The interrupt is disabled when this bit is low. This bit is cleared by reset.

Bit 7 When this bit is high, a tick timer interrupt is being generated at the level programmed in bits 0-2. This bit is edge sensitive and it is set by a carry out of the tick timer when interrupts are enabled. This bit is cleared when a one is written to it or when the interrupt is disabled. When cleared, it remains cleared until the next carry out. This bit is cleared by reset.

Timer 1 Control Register

The table below shows the timer 1 control register.

Address	Bit7	Bit6	Bit5	Bit4	Bit 3	Bit 2	Bit 1	Bit 0
FFFE1019	Ovf3	Ovf2	Ovf1	Ovf0		ClrOvf	EnActr	Enable
	R	R	R	R		W	R/W	R/W

- Bit 0** When this bit is low, the timer is disabled and the counter is loaded with the preload value. When the bit is high, the counter is enabled and it starts counting up if the counter enable bit (bit 1) is high. This bit is cleared by reset.
- Bit 1** When this bit is low, the counter is stopped. The counter value is not changed when the counter is stopped and started with this bit. When this bit is high, the counter is enabled. This bit is cleared by reset.
- Bit 2** The overflow counter is cleared by writing a one to this bit.
- Bits 4-7** These read only bits are the output of the overflow counter. The overflow counter is incremented each time the tick timer rolls over. These bits are cleared by reset.

Timer 2 Interrupt Control Register

The table below shows the timer 2 interrupt control register.

Address	Bit7	Bit6	Bit5	Bit4	Bit 3	Bit 2	Bit 1	Bit 0
FFFE101A	Int stat				Enable	IL2	IL1	IL0
	R/C				R/W	R/W	R/W	R/W

Note Bit set and clear instructions should not be used on this interrupt control register. Because an interrupt is cleared by writing a one to the status bit and the status bit is a one to indicate a pending interrupt, the read-modify-write sequence may clear a pending interrupt.

- Bits 0-2** These bits program the interrupt level the tick timer generates. Because level 0 does not generate an interrupt, this level is intended for polling software. These bits are cleared by reset.
- Bit 3** When this bit is high, the interrupt is enabled. The interrupt is disabled when this bit is low. This bit is cleared by reset.
- Bit 7** When this bit is high, a tick timer interrupt is being generated at the level programmed in bits 0-2. This bit is edge sensitive and it is set by a carry out of the tick timer when interrupts are enabled. This bit is cleared when a one is written to it or when the interrupt is disabled. When cleared, it remains cleared until the next carry out. This bit is cleared by reset.

Timer 2 Control Register

The table below shows the timer 2 control register.

Address	Bit7	Bit6	Bit5	Bit4	Bit 3	Bit 2	Bit 1	Bit 0
FFFE101B	Ovf3	Ovf2	Ovf1	Ovf0		ClrOvf	EnActr	Enable
	R	R	R	R		W	R/W	R/W

- Bit 0** When this bit is low, the timer is disabled and the counter is loaded with the preload value. When the bit is high, the counter is enabled and it starts counting up if the counter enable bit (bit 1) is high. This bit is cleared by reset.
- Bit 1** When this bit is low, the counter is stopped. The counter value is not changed when the counter is stopped and started with this bit. When this bit is high, the counter is enabled. This bit is cleared by reset.
- Bit 2** The overflow counter is cleared by writing a one to this bit.
- Bits 4-7** These read only bits are the output of the overflow counter. The overflow counter is incremented each time the tick timer over. These bits are cleared by reset.

AC Fail Interrupt Control Register

The table below shows the AC Fail interrupt control register.

Address	Bit7	Bit6	Bit5	Bit4	Bit 3	Bit 2	Bit 1	Bit 0
FFFE101C	Int stat	AC Fail			Enable			
	R/C	R			R/W			

- Bit 3** When this bit is high, the interrupt is enabled. The interrupt is disabled when this bit is low. This bit is cleared by reset.
- Bit 6** When this bit is low, the VMEbus ACFAIL* signal is not active. When this bit is high, the VMEbus ACFAIL* signal is active.
- Bit 7** When this bit is high, an AC Fail interrupt is being generated at level 7. This bit is edge sensitive and it is set on the leading edge of interrupt enable and AC Fail. This bit is cleared when a one is written to it or when the interrupt is disabled. When cleared, it remains cleared until the next leading edge of interrupt enable and AC Fail. This bit is cleared by reset.

Watchdog Timer Control Register

The table below shows the watchdog timer control register.

Address	Bit7	Bit6	Bit5	Bit4	Bit 3	Bit 2	Bit 1	Bit 0
FFFE101D	WDL3	WDL2	WDL1	WDL0	WDTO	WDRst	WDClr	Enable
	R/W	R/W	R/W	R/W	R/C	R/W	W	R/W

Note Bit set and clear instructions should not be used on this control register. Because the WD time-out bit is cleared by writing a one to it and the status bit is a one to indicate a time-out, the read-modify-write sequence may clear the WD time-out.

Bit 0 When this bit is low, the watchdog timer is disabled. When this bit is high, the watchdog timer is enabled, and increments each time tick timer 1 rolls over. This bit is cleared by reset.

Bit 1 The watchdog timer is cleared by writing a one to this bit.

Bit 2 When this bit is low, the watchdog timer does not activate the reset signal if a time-out occurs. When this bit is high, the watchdog timer activates the reset signal if a time-out occurs. This bit is cleared by reset. This bit should only be set if the MVME147 is system controller.

Bit 3 This bit is set if the watchdog timer times out. This bit is cleared by writing a one to it. This bit is cleared by power up reset.

Bits 4-7 These bits set the watchdog limit. When the watchdog timer value is equal to the watchdog limit, the WD TOUT bit is set. These bits are cleared by reset.

Printer Interrupt Control Register

The table below shows the printer interrupt control register.

Address	Bit7	Bit6	Bit5	Bit4	Bit 3	Bit 2	Bit 1	Bit 0
FFFE101E	Int stat	FaltInt	ACKInt	ACKPol	Enable	IL2	IL1	IL0
	R	R/C	R/C	R/W	R/W	R/W	R/W	R/W

Note Bit set and clear instructions should not be used on this control register. Because the interrupt is cleared by writing a one to status bit and the status bit is a one to indicate a pending interrupt, the read-modify-write sequence may clear a pending interrupt.

- Bits 0-2** These bits program the interrupt level the printer generates. Level 0 does not generate an interrupt. These bits are cleared by reset.
- Bit 3** When this bit is high, the interrupt is enabled. The interrupt is disabled when this bit is low. This bit is cleared by reset.
- Bit 4** When this bit is low, the rising edge of ACK* generates an interrupt. When this bit is high, the falling edge of ACK* generates an interrupt. This bit is cleared by reset.
- Bit 5** When interrupts are enabled, this bit is set by the rising or falling edge of ACK* as selected by bit 4. This bit is edge sensitive and is cleared by writing a one to it or when interrupts are disabled.
- Bit 6** When interrupts are enabled, this bit is set by the falling edge of FAULT*. This bit is edge sensitive and is cleared by writing a one to it or when interrupts are disabled.
- Bit 7** When this bit is high, a printer interrupt is being generated at the level programmed in bits 0-2. This bit is the OR of bits 5 and 6. This bit is cleared by reset.

Printer Control Register

The table below shows the printer control register.

Address	Bit7	Bit6	Bit5	Bit4	Bit 3	Bit 2	Bit 1	Bit 0
FFFE101F					In Prim	Strobe	Stb Tim	Mode
					R/W	R/W	R/W	R/W

- Bit 0** This bit selects the auto or manual mode for the printer strobe. When this bit is low, the printer strobe is generated by a write to the printer data register (auto mode). When this bit is high, the printer strobe is not generated by a write to the printer data register (manual mode). This bit is cleared by reset.
- Bit 1** This bit controls the printer strobe timing in the auto mode. When this bit is low, the strobe time in the auto mode is 2 μ s. When this bit is high, the strobe time in the auto mode is 8 μ s. The strobe time is also the time delay from the write to the printer data register to the assertion of the printer strobe. This bit is cleared by reset.

STB*

<--- 2/8 μs --->

<--- 2/8 μs --->|

Bit 2 This bit controls the printer strobe in the manual mode. In the manual mode, the software must control the timing. When this bit is low, the printer strobe is not activated. When this bit is high, the printer strobe is activated. This bit is cleared by reset.

Bit 3 This bit controls the input prime signal. When this bit is low, the input prime signal is not activated. When this bit is high, the input prime signal is activated. The software must control the timing of the printer input prime signal. This bit is cleared by reset.

DMA Interrupt Control Register

The table below shows the DMA interrupt control register.

Address	Bit7	Bit6	Bit5	Bit4	Bit 3	Bit 2	Bit 1	Bit 0
FFFE1020	Int stat				Enable	IL2	IL1	IL0
	R/C				R/W	R/W	R/W	R/W

Note Bit set and clear instructions should not be used on this control register. Because the interrupt is cleared by writing a one to the status bit and the status bit is a one to indicate a pending interrupt, the read-modify-write sequence may clear a pending interrupt.

Bits 0-2 These bits program the interrupt level the DMA controller generates. Level 0 does not generate an interrupt. These bits are cleared by reset.

Bit 3 When this bit is high, the interrupt is enabled. The interrupt is disabled when this bit is low. This bit is cleared by reset.

Bit 7 When this bit is high, a DMA interrupt is being generated at the level programmed in bits 0-2. This bit is edge sensitive and it is set on the leading edge of interrupt enable and DMA DONE. This bit is cleared when a one is written to it or when the interrupt is disabled. When cleared, it remains cleared until the next leading edge of interrupt enable and DMA DONE. This bit is cleared by reset.

DMA Control and Status Register

The table below shows the DMA control and status register.

Address	Bit7	Bit6	Bit5	Bit4	Bit 3	Bit 2	Bit 1	Bit 0
FFFE1021	DONE	8 Bit E	Tbl Siz	DMA bus	Tbl bus	MS/SM*	TW	Enable
	R	R	R	R	R	R/W	R/W	R/W

All bits are cleared by reset.

- Bit 0** When this bit is low, the DMA controller is disabled and status bits 3-7 are reset. When this bit is high, the DMA controller is enabled.
- Bit 1** This bit controls the mode of the DMA controller. When this bit is low, the DMA controller uses the address and byte count in the address and byte count registers. When this bit is high, the DMA controller uses address and byte counts in a table pointed to by the table address register.
- Bit 2** This bit controls the direction the data is transferred. When this bit is low, the DMA controller transfers data from the SCSI bus. When this bit is high, the DMA controller transfers data to the SCSI bus.
- Bit 3** This bit is set if a bus error occurred while the DMA controller was accessing the address table. This bit is reset when the DMA controller is disabled.
- Bit 4** This bit is set if a bus error occurred while the DMA controller was transferring data. This bit is reset when the DMA controller is disabled.
- Bit 5** This bit is set if the DMA controller accesses a table entry that is not located in 32-bit memory. This bit is reset when the DMA controller is disabled.
- Bit 6** This bit (8-bit error) is set if the DMA controller receives a handshake indicating the port was 8 bits. This bit is reset when the DMA controller is disabled.
- Bit 7** This bit is set when the DMA controller has stopped because all the data has been transferred or an error has occurred. This bit is reset when the DMA controller is disabled.

Bus Error Interrupt Control Register

The table below shows the bus error interrupt control register.

Address	Bit7	Bit6	Bit5	Bit4	Bit 3	Bit 2	Bit 1	Bit 0
FFFE1022	Int stat				Enable			
	R/C				R/W			

Bit 3 When this bit is high, the interrupt is enabled. The interrupt is disabled when this bit is low. This bit is cleared by reset.

Bit 7 When this bit is high, a bus error interrupt is being generated at Level 7. This bit is set when the processor receives a bus error and the interrupt is enabled. This bit is cleared when a one is written to it or when the interrupt is disabled. When cleared, it remains cleared until the next bus error. This bit is cleared by reset.

DMA Status Register

The table below shows the DMA status register.

Address	Bit7	Bit6	Bit5	Bit4	Bit 3	Bit 2	Bit 1	Bit 0
FFFE1023	Inc 4	Inc 3	Inc 2	Inc 1	UU	UM	LM	LL
	R	R	R	R	R	R	R	R

Bits 0-3 The PCC has a 32-bit register which is used to hold data that is transferred between the SCSI bus and the local bus. Bits 0-3 indicate the status of each byte of the holding register. When a bit is low, the corresponding byte is empty. When a bit is high, the corresponding byte is full. These bits are cleared when the DMA controller is disabled. These bits are cleared by reset.

Bits 4-7 The DMA address and byte counters may be incremented by 1, 2, 3, or 4. When the DMA counters are incremented, the increment value is saved in these bits. Only one of the 4 bits is set. These bits are cleared when the DMA controller is disabled. These bits are cleared by reset.

Abort Interrupt Control Register

The table below shows the abort interrupt control register.

Address	Bit7	Bit6	Bit5	Bit4	Bit 3	Bit 2	Bit 1	Bit 0
FFFE1024	Int stat	Abort			Enable			
	R/C	R			R/W			

Note Bit set and clear instructions should not be used on this control register. Because the interrupt is cleared by writing a one to the status bit and the status bit is a one to indicate a pending interrupt, the read-modify-write sequence may clear a pending interrupt.

- Bit 3** When this bit is high, the interrupt is enabled. The interrupt is disabled when this bit is low. This bit is cleared by reset.
- Bit 6** This bit indicates the current state of the ABORT switch. When this bit is low, the ABORT switch is not pressed. When this bit is high, the ABORT switch is pressed.
- Bit 7** When this bit is high, an abort interrupt is being generated at Level 7. This bit is edge sensitive and it is set on the leading edge of interrupt enable and abort. This bit is cleared when a one is written to it or when the interrupt is disabled. When cleared, it remains cleared until the next leading edge of interrupt enable and abort. This bit is cleared by reset.

Table Address Function Code Register

The table below shows the table address function code register.

Address	Bit7	Bit6	Bit5	Bit4	Bit 3	Bit 2	Bit 1	Bit 0
FFFE1025						Tbl FC2	Tbl FC1	Tbl FC0
						R/W	R/W	R/W

Bits 0-2 This function code is placed on the local bus when the DMA address table is accessed. Note that a value of 1, 2, 5, or 6 must be placed in Tbl FC2-FC0 for proper operation of the MVME147S during table walking. These bits are cleared by reset.

Serial Port Interrupt Control Register

The table below shows the serial port interrupt control register.

Address	Bit7	Bit6	Bit5	Bit4	Bit 3	Bit 2	Bit 1	Bit 0
FFFE1026	Int stat			Int/Ext	Enable	IL2	IL1	IL0
	R			R/W	R/W	R/W	R/W	R/W

All bits are cleared by reset.

- Bits 0-2** These bits program the interrupt level that the serial ports generate. Level 0 does not generate an interrupt.
- Bit 3** When this bit is high, the interrupt is enabled. The interrupt is disabled when this bit is low.
- Bit 4** This bit controls the vector source. When this bit is low, the interrupt status/id vector comes from the serial chip. When this bit is high, the interrupt status/id vector comes from the PCC.
- Bit 7** When this bit is high, a serial port interrupt is being generated at the level programmed in bits 0-2. This bit is level sensitive and it is active when interrupt enable and serial port interrupt are active.

General Purpose Control Register

The table below shows the general purpose control register.

Address	Bit7	Bit6	Bit5	Bit4	Bit 3	Bit 2	Bit 1	Bit 0
FFFE1027	Rs Dis2	Rs Dis1	Rs Dis0	MIntEn	LbToEn	WWPar	ParEn1	ParEn0
	R/W(1)	R/W(0)	R/W(1)	R/W	R/W	R/W	R/W	R/W

- Bits 0-1** These bits control local RAM parity checking. These bits should not be enabled on the MVME147SRF. These bits are cleared by reset.

Note The DRAM parity on the MVME147S is in an undefined state after power up. Reads to an uninitialized memory with parity checking enabled cause bus errors. All DRAM locations should be written to ensure correct parity before checking is enabled.

- 0** Local RAM parity checking is disabled.
- 1** Local RAM parity checking is enabled and BERR is asserted during the current DRAM access cycle (adds 1 wait cycle).
- 2** Local RAM parity checking is disabled.

- 3** Local DRAM parity checking is enabled. BERR is asserted on the current cycle (adds 1 wait cycle) for LANCE, VME, and PCC accesses to DRAM. BERR is asserted on the next DRAM access cycle for MC68030 accesses to DRAM (adds 0 wait cycles). Note that not only is BERR asserted during the next MC68030 DRAM access cycle but it is asserted during all subsequent MC68030 DRAM access cycles. This helps stop the MC68030 from proceeding when DRAM is bad.
- Bit 2** This bit is used to test the parity generating and checking logic. When this bit is low, correct parity is written to the DRAM; when high, incorrect parity is written to the DRAM. This bit is cleared by reset.
- Bit 3** When set, this bit is used to enable the local bus timer that is part of the PCC. Because the VME chip also contains a local bus timer, this bit should be cleared, turning off the PCC local bus timer. This bit is cleared by reset.
- Bit 4** This bit is the master interrupt enable. When this bit is low, interrupts are disabled; when high, interrupts are enabled. This bit is cleared by reset.
- Bits 5-7** When the pattern %101 is written to these bits, the front panel RESET switch is disabled. The RESET switch is enabled for any other pattern. These bits are cleared by reset.

LAN Interrupt Control Register

The table below shows the LAN interrupt control register. The LAN interrupt is not used on the MVME147SRF and should not be enabled.

Address	Bit7	Bit6	Bit5	Bit4	Bit 3	Bit 2	Bit 1	Bit 0
FFFE1028	Int stat				Enable	IL2	IL1	IL0
	R				R/W	R/W	R/W	R/W

- Bits 0-2** These bits program the interrupt level the LAN chip generates. Level 0 does not generate an interrupt. These bits are cleared by reset.
- Bit 3** When this bit is high, the interrupt is enabled. The interrupt is disabled when this bit is low. This bit is cleared by reset.
- Bit 7** When this bit is high, a LAN port interrupt is being generated at the level programmed in bits 0-2. This bit is level sensitive and it is active when interrupt enable and LAN interrupt are active. This bit is cleared by reset.

General Purpose Status Register

The table below shows the general purpose status register.

Address	Bit7	Bit6	Bit5	Bit4	Bit 3	Bit 2	Bit 1	Bit 0
FFFE1029							PuReset	ParErr
							R/C	R/C

Bit 0 This bit is set when a parity error occurs while the local processor is accessing RAM. This bit is cleared by writing a one to it. This bit is cleared by reset.

Bit 1 This bit is set when a power up reset occurs. It is cleared by writing a one to it. When the MVME147BUG is installed, its initialization code clears this bit.

SCSI Port Interrupt Control Register

The table below shows the SCSI port interrupt control register.

Address	Bit7	Bit6	Bit5	Bit4	Bit 3	Bit 2	Bit 1	Bit 0
FFFE102A	Int stat	SCSIRst	SCSIRst	RstSCSI	Enable	IL2	IL1	IL0
	R	R/C	R	R/W	R/W	R/W	R/W	R/W

Note Bit set and clear instructions should not be used on this control register. Because the interrupt is cleared by writing a one to status bit and the status bit is a one to indicate a pending interrupt, the read-modify-write sequence may clear a pending interrupt.

Bits 0-2 These bits program the interrupt level the SCSI port generates. Level 0 does not generate an interrupt. These bits are cleared by reset.

Bit 3 When this bit is high, the interrupt is enabled. The interrupt is disabled when this bit is low. This bit is cleared by reset.

Bit 4 This bit is used to control the reset signal on the SCSI bus. When this bit is low, the SCSI reset signal is not driven by MVME147S. When this bit is high, the SCSI reset is driven by MVME147S. This bit is cleared by reset.

- Bit 5** This bit indicates the state of the SCSI reset signal. When this bit is low, the SCSI reset signal is not active. When this bit is high, the SCSI reset signal is active.
- Bit 6** When this bit is high, a SCSI reset interrupt is being generated at the level programmed in bits 0-2. This bit is edge sensitive and it is set on the leading edge of interrupt enable and SCSI reset. This bit is cleared when a one is written to it or when the interrupt is disabled. When cleared, it remains cleared until the next leading edge of interrupt enable and SCSI reset. This bit is cleared by reset.
- Bit 7** When this bit is high, a SCSI port interrupt is being generated at the level programmed in bits 0-2. This bit is the OR of bit 6 and the SCSI chip interrupt. This bit is cleared by reset.

Slave Base Address Register

The table below shows the slave base address register.

Address	Bit7	Bit6	Bit5	Bit4	Bit 3	Bit 2	Bit 1	Bit 0
FFFE102B	LANA25	LANA24	WAITRMC	RBA4	RBA3	RBA2	RBA1	RBA0
	R/W	R/W	R/W	R/W	R/W	R/W	R/W	R/W

All bits are cleared by reset.

- Bits 0-4** These bits set the slave RAM base address, or the address of onboard RAM as viewed from the VMEbus.

Table 4-2. DRAM Address as Viewed from the VMEbus

					Beginning	Ending	
RBA4	RBA3	RBA2	RBA1	RBA0	Address	Address	Notes
0	0	0	0	0	\$00000000	(1 x DRAMsize)-1	
0	0	0	0	1	1 x DRAMsize	(2 x DRAMsize)-1	1,2
0	0	0	1	0	2 x DRAMsize	(3 x DRAMsize)-1	1,2
0	0	0	1	1	3 x DRAMsize	(4 x DRAMsize)-1	1,2
0	0	1	0	0	4 x DRAMsize	(5 x DRAMsize)-1	1,2
0	0	1	0	1	5 x DRAMsize	(6 x DRAMsize)-1	1,2
0	0	1	1	0	6 x DRAMsize	(7 x DRAMsize)-1	1,2
0	0	1	1	1	7 x DRAMsize	(8 x DRAMsize)-1	1,2
0	1	0	0	0	8 x DRAMsize	(9 x DRAMsize)-1	1,2

Table 4-2. DRAM Address as Viewed from the VMEbus (Continued)

					Beginning	Ending	
RBA4	RBA3	RBA2	RBA1	RBA0	Address	Address	Notes
0	1	0	0	1	9 x DRAMsize	(10 x DRAMsize)-1	1,2
0	1	0	1	0	10 x DRAMsize	(11 x DRAMsize)-1	1,2
0	1	0	1	1	11 x DRAMsize	(12 x DRAMsize)-1	1,2
0	1	1	0	0	12 x DRAMsize	(13 x DRAMsize)-1	1,2
0	1	1	0	1	13 x DRAMsize	(14 x DRAMsize)-1	1,2
0	1	1	1	0	14 x DRAMsize	(15 x DRAMsize)-1	1,2
0	1	1	1	1	15 x DRAMsize	(16 x DRAMsize)-1	1,2
1	0	0	0	0	16 x DRAMsize	(17 x DRAMsize)-1	1,2
1	0	0	0	1	17 x DRAMsize	(18 x DRAMsize)-1	1,2
1	0	0	1	0	18 x DRAMsize	(19 x DRAMsize)-1	1,2
1	0	0	1	1	19 x DRAMsize	(20 x DRAMsize)-1	1,2
1	0	1	0	0	20 x DRAMsize	(21 x DRAMsize)-1	1,2
1	0	0	0	0	16 x DRAMsize	(17 x DRAMsize)-1	1,2
1	0	0	0	1	17 x DRAMsize	(18 x DRAMsize)-1	1,2
1	0	0	1	0	18 x DRAMsize	(19 x DRAMsize)-1	1,2
1	0	0	1	1	19 x DRAMsize	(20 x DRAMsize)-1	1,2
1	0	1	0	0	20 x DRAMsize	(21 x DRAMsize)-1	1,2
Notes							
1	DRAMsize = the size of the DRAM. For example, if the 4MB version is used, then DRAMsize = \$400000, and (3 x DRAMsize)-1 = \$BFFFFF.						
2	When beginning address is less than 16MB, the DRAM responds to standard or extended address modifiers. When beginning address is 16MB or greater, the DRAM responds to extended address modifiers only. Note that bits 4 and 5 in the VMEchip Slave Address Modifier Register further control response to standard and extended address modifiers.						
3	This combination pertains only to DRAMsize of 16MB or 32MB.						
4	The values shown in the table refer to extended addresses only. In the standard address range the DRAM responds to \$000000 through \$7FFFFFFF.						

Bit 5 WAITRMC controls the MVME147S implementation of multiple address RMC (MARMC) cycles. When WAITRMC is set, the MVME147S always waits for VMEbus mastership before executing an MARMC cycle. WAITRMC should be set if it is desired to guarantee indivisibility of MARMC cycles (only guaranteed if the other master implements MARMC cycles the same way as the MVME147S).

When WAITRMC is cleared, the MVME147S only waits for VMEbus mastership if the MARMC cycle starts out by going to the VMEbus.

Note that regardless of the state of the WAITRMC bit, if the MVME147S obtains VMEbus mastership during an MARMC, it maintains it until all of the cycles of the MARMC are completed.

Bits 6,7 These bits determine the section of local DRAM that is accessible to the LANCE during DMA.

Table 4-3. DRAM Accessed by the LANCE

		Section of DRAM
LANA25	LANA24	Accessible to LANCE
0	0	\$00000000-00FFFFFF
0	1	\$01000000-01FFFFFF
1	0	\$02000000-02FFFFFF
1	1	\$03000000-03FFFFFF

Software Interrupt 1 Control Register

The table below shows the software interrupt 1 control register.

Address	Bit7	Bit6	Bit5	Bit4	Bit 3	Bit 2	Bit 1	Bit 0
FFFE102C	Int stat				Enable	IL2	IL1	IL0
	R				R/W	R/W	R/W	R/W

Bits 0-2 These bits program the interrupt level that is generated. Level 0 does not generate an interrupt. These bits are cleared by reset.

Bit 3 When this bit is high, the interrupt is enabled. The interrupt is disabled when this bit is low. This bit is cleared by reset.

Bit 7 This bit is low when the interrupt is disabled and it is high when the interrupt is enabled. This bit is cleared by reset.

Interrupt Base Vector Register

The table below shows the interrupt base vector register.

Address	Bit7	Bit6	Bit5	Bit4	Bit 3	Bit 2	Bit 1	Bit 0
FFFE102D	Ivb 7	Ivb 6	Ivb 5	Ivb 4				
	R/W	R/W	R/W	R/W				

Bits 4-7 These bits set the base interrupt status/id vector for interrupts whose vectors originate from the PCC. The lower four bits are determined by the interrupting device. These bits are cleared by reset.

Bits 3-0

	3	2	1	0
AC Fail	0	0	0	0
BERR	0	0	0	1
Abort	0	0	1	0
Serial port (when enabled by PCC)	0	0	1	1
LANCE	0	1	0	0
SCSI port	0	1	0	1
SCSI DMA	0	1	1	0
Printer port	0	1	1	1
Tick timer 1	1	0	0	0
Tick timer 2	1	0	0	1
Software interrupt 1	1	0	1	0
Software interrupt 2	1	0	1	1

Software Interrupt 2 Control Register

The table below shows the software interrupt 2 control register.

Address	Bit7	Bit6	Bit5	Bit4	Bit 3	Bit 2	Bit 1	Bit 0
FFFE102E	Int stat				Enable	IL2	IL1	IL0
	R				R/W	R/W	R/W	R/W

4

- Bits 0-2** These bits program the interrupt level that is generated. Level 0 does not generate an interrupt. These bits are cleared by reset.
- Bit 3** When this bit is high, the interrupt is enabled. The interrupt is disabled when this bit is low. This bit is cleared by reset.
- Bit 7** This bit is low when the interrupt is disabled and it is high when the interrupt is enabled. This bit is cleared by reset.

Revision Level Register

The table below shows the revision level register.

Address	Bit7	Bit6	Bit5	Bit4	Bit 3	Bit 2	Bit 1	Bit 0
FFFE102F	RevL 7	RevL 6	RevL 5	RevL 4	RevL 3	RevL 2	RevL 1	RevL 0
	R	R	R	R	R	R	R	R

- Bits 0-7** These bits represent the revision level of the PCC. Initial parts are released as level 0. If functional changes are required in future parts, the revision level is incremented. This allows the software to configure itself should functional changes be required in the PCC.

Printer Data Register

The table below shows the printer data register.

Address	Bit7	Bit6	Bit5	Bit4	Bit 3	Bit 2	Bit 1	Bit 0
FFFE2800	PD7	PD6	PD5	PD4	PD3	PD2	PD1	PD0
	W/O	W/O	W/O	W/O	W/O	W/O	W/O	W/O

Bits 0-7 These bits form the printer data lines. They are write only. Reading this address accesses the printer status register. These bits are not affected by reset.

Printer Status Register

The table below shows the printer status register.

Address	Bit7	Bit6	Bit5	Bit4	Bit 3	Bit 2	Bit 1	Bit 0
FFFE2800	ACK	FAULT	SELECT	PE	BSY		LOW	STAT12
	R/O	R/O	R/O	R/O	R/O		R/O	R/O

Bit 0 STAT12 indicates the status of the fused +12V power for Ethernet transceiver power and for serial port pull up power.

Bit 1 LOW is always 0.

Bit 3 BSY is 1 when the printer is busy and 0 when it is not. This is a read only bit.

Bit 4 PE is 1 when the printer is in the paper empty state and 0 when it is not.

Bit 5 SELECT is 1 when the printer is selected and 0 when it is not.

Bit 6 FAULT is 1 when the printer is in the fault state and 0 when it is not.

Bit 7 ACK is 1 when printer acknowledge is true and 0 when it is not.

These bits are not affected by reset.

Programming the VMEchip

The VMEchip has two groups of registers: the Local Control and Status Registers (LCSR) and the Global Control and Status Registers (GCSR).

Programming the LCSR

There are 14 LCSR registers as shown in the following table.

Table 4-4. VMEchip Local Control and Status Registers

Address	Bit 7	Bit 6	Bit 5	Bit 4	Bit 3	Bit 2	Bit 1	Bit 0
FFFE2001					ROBIN	BRDFAIL	SRESET	SCON
FFFE2003	DWB	DHB	RONR	RWD	RNEVER		RQLEV1	RQLEV0
FFFE2005	DDTACK	020	MASWP	CFILL	MASUAT	MASA16	MASA24	MASD16
FFFE2007	SLVEN		SLVWP					SLVD16
FFFE2009		ARBTO	VBTO1	VBTO0	ACTO1	ACTO0	LBTO1	LBTO0
FFFE200B	SUPER	USER	EXTED	STND	SHORT	BLOCK	PRGRM	DATA
FFFE200D	AMSEL		AM 5	AM 4	AM 3	AM 2	AM 1	AM 0
FFFE200F	IEN 7	IEN 6	IEN 5	IEN 4	IEN 3	IEN 2	IEN 1	
FFFE2011	WPERREN	SFIEN	SIGHEN	LMIEN	IACKEN	LM0EN	SIGLEN	
FFFE2013	UVB 7	UVB 6	UVB 5	UVB 4	UVB 3	UID 2	UID 1	UID 0
FFFE2015						IL2	IL1	IL0
FFFE2017	D07	D06	D05	D04	D03	D02	D01	D00
FFFE2019					RMCERR	VBERR	ACTO	LBTO
FFFE201B					GCSRA7	GCSRA6	GCSRA5	GCSRA4

System Controller Configuration Register

The table below shows the system controller configuration register.

Address	Bit7	Bit6	Bit5	Bit4	Bit 3	Bit 2	Bit 1	Bit 0
FFFE2001					ROBIN	BRDFAIL	SRESET	SCON

Bit 0 The SCON status bit is a reflection of the configuration of header J3. When J3 pins 1 and 2 are connected, enabling the MVME147S to act as the VMEbus system controller, then SCON = 1. When J3 pins 1 and 2 are not connected, the MVME147S is not the VMEbus system controller and SCON = 0.

Bit 1 This bit allows the software to initiate a global reset sequence. Setting the SRESET bit activates the SYSRESET* signal on the VMEbus which in turn resets the MVME147S. This bit clears automatically after the reset is complete. This bit is cleared by any reset.

Bit 2 Setting BRDFAIL to one causes the VMEchip to attempt to activate the SYSFAIL* signal on the VMEbus. The GCSR bit Inhibit SYSFAIL (ISF), in global register 1, enables the MVME147S to cause SYSFAIL* to be activated as a result of the state of BRDFAIL. In addition, when the bit is set, the FAIL LED is lit. (A watchdog time-out from the PCC also lights the FAIL LED.) This bit is set by any reset.

Bit 3 The ROBIN bit configures the VMEbus arbitration mode. ROBIN = 1 forces the round-robin mode. ROBIN = 0 forces the priority mode. Both modes can be used by the MVME147S. This bit is cleared by SYSRESET.

VMEbus Requester Configuration Register

The table below shows the VMEbus requester configuration register.

Address	Bit7	Bit6	Bit5	Bit4	Bit 3	Bit 2	Bit 1	Bit 0
FFFE2003	DWB	DHB	RONR	RWD	RNEVER		RQLEV1	RQLEV0

Bits 0-1 These control bits configure the VMEbus requester level as shown in the table below:

RQLEV1	RQLEV0	Level
0	0	0
0	1	1
1	0	2
1	1	3

These bits are set to 1, 1 by any reset.

Note that writes to REQLEV1,0 do not change the actual requester level until the MVME147S goes through the action of having VMEbus mastership and releasing it. This means that there are times when the value written into REQLEV1,0 do not match the current requester level (the request level is lagging). During such times, reads to REQLEV1,0 reflect the actual requester level, not the value written into REQLEV1,0.

Bit 3 Setting this bit to one prevents the requester from releasing the VMEbus. However, unlike the DWB control bit, setting the RNEVER bit does not cause the requester to request the VMEbus. Clearing the RNEVER bit allows the requester to relinquish the VMEbus in accordance with the other control bits of the requester configuration register. This bit is cleared by any reset.

- Bit 4** The RWD bit allows software to configure the requester release mode. When the bit is set, if RNEVER and DWB are both cleared to 0, the requester releases the VMEbus after the MC68030 completes a VMEbus cycle. When the bit is cleared, if RNEVER and DWB are both cleared to 0, the requester operates in the Release-On-Request (ROR) mode. After acquiring control of the VMEbus, it maintains control until it detects another request pending on the VMEbus. This bit is cleared by any reset.
- Bit 5** The RONR bit controls the manner in which the VMEchip requests the VMEbus. When the bit is set; anytime the MVME147S has bus mastership, then gives it up, the VMEchip does not request the VMEbus again until it detects the bus request signal BR*, on its level, negated for at least 150 ns. When the VMEchip detects BR* negated, it refrains from driving it again for at least 200 ns. This bit is cleared by any reset.
- Bit 6** The DHB status bit is 1 when the MVME147S is VMEbus master and 0 when it is not.
- Bit 7** Setting the DWB control bit to 1 causes the VMEchip to request the VMEbus (if not already bus master). When VMEbus mastership has been obtained, it is not relinquished until after the DWB and RNEVER bits are both cleared. This bit is cleared by any reset.

Master Configuration Register

The table below shows the master configuration register.

Address	Bit7	Bit6	Bit5	Bit4	Bit 3	Bit 2	Bit 1	Bit 0
FFFE2005	DDTACK	020	MASWP	CFILL	MASUAT	MASA16	MASA24	MASD16

- Bit 0** Setting the MASD16 bit forces the MVME147S to perform only D8 and D16 data transfers on the VMEbus. Clearing the MASD16 bit allows D8, D16, and D32 transfer capability on the VMEbus when the MC68030 accesses in the range below \$F0000000. (Accesses to VMEbus locations above \$F0000000 are always restricted to D8/D16 regardless of the MASD16 bit.) This bit is cleared by SYSRESET.
- Bit 1** If either the MASA24 bit is set, or the MC68030 accesses the VMEbus in the range below \$1000000, the master drives one of the standard (24-bit) address modifier codes during VMEbus cycles (unless the master is configured to use the master address modifier register as described in *Master Address Modifier Register* in this chapter). The specific standard AM code is determined from the levels that the MC68030 drives on the three function code lines during the cycle, as shown in the table below. This bit is cleared by SYSRESET.

Bit 2 If either the MASA16 bit is set, or the MC68030 accesses the VMEbus in the range above \$FFFF0000, a short (16-bit) AM code is used regardless of the state of the MASA24 bit (unless the master is configured to use the master address modifier register as described in *Master Address Modifier Register* in this chapter). The specific short AM code is determined from the levels that the MC68030 drives on the three function code lines during the cycle, as shown in the table below. This bit is cleared by SYSRESET.

Bit 3 The MASUAT bit allows software to configure the master to provide the UAT data transfer capability. Setting the MASUAT bit to 1 configures the master to execute unaligned VMEbus cycles when necessary. If the bit is cleared, the MC68030 is acknowledged so as to break the unaligned transfer into multiple aligned cycles. This bit is cleared by SYSRESET.

Note While making it optional for the master to provide the UAT data transfer capability, the VMEbus specification requires that all D32 slaves support it.

Table 4-5. Determining the Master AM Code

M		M						VMEbus Address Modifier							
A	A	A	A												
S	D	S	D												
A	R	A	R	F	F	F		A	A	A	A	A	A		
1	1	2	2	C	C	C		M	M	M	M	M	M		
6	6	4	4	2	1	0		5	4	3	2	1	0	CODE	
0	F	0	F	0	0	1		0	0	1	0	0	1	\$09	
0	F	0	F	0	1	0		0	0	1	0	1	0	\$0A	
0	F	0	F	1	0	1		0	0	1	1	0	1	\$0D	
0	F	0	F	1	1	0		0	0	1	1	1	0	\$0E	
1	X	X	X	0	0	1		1	0	1	0	0	1	\$29	
1	X	X	X	0	1	0		1	0	1	0	1	0	\$2A	
X	T	X	X	0	0	1		1	0	1	0	0	1	\$29	
X	T	X	X	0	1	0		1	0	1	0	1	0	\$2A	
1	X	X	X	1	0	1		1	0	1	1	0	1	\$2D	
1	X	X	X	1	1	0		1	0	1	1	1	0	\$2E	
X	T	X	X	1	0	1		1	0	1	1	0	1	\$2D	

Table 4-5. Determining the Master AM Code (Continued)

M		M						VMEbus Address Modifier						
X	T	X	X	1	1	0		1	0	1	1	1	0	\$2E
0	F	1	X	0	0	1		1	1	1	0	0	1	\$39
0	F	1	X	0	1	0		1	1	1	0	1	0	\$3A
0	F	1	X	1	0	1		1	1	1	1	0	1	\$3D
0	F	1	X	1	1	0		1	1	1	1	1	0	\$3E
0	F	X	T	0	0	1		1	1	1	0	0	1	\$39
0	F	X	T	0	1	0		1	1	1	0	1	0	\$3A
0	F	X	T	1	0	1		1	1	1	1	0	1	\$3D
0	F	X	T	1	1	0		1	1	1	1	1	0	\$3E
T = True, F = False, X = Don't Care														
Note that AM2, 1, 0 track FC2, 1, 0														

ADR16 = T represents MC68030 accesses to the VMEbus above \$FFFF0000.

ADR16 = F represents MC68030 accesses to the VMEbus below \$FFFF0000.

ADR24 = T represents MC68030 accesses to the VMEbus below \$01000000.

ADR24 = F represents MC68030 accesses to the VMEbus above \$01000000.

Bit 4

This bit is cleared by SYSRESET. It should remain cleared.

Bit 5

Setting the MASWP bit speeds up MC68030 writes to the VMEbus. However, it should be used with caution. When MASWP (Master Write Posting) is set, MC68030 write cycles to the VMEbus are acknowledged by the VMEchip, before they have actually finished on the VMEbus. The VMEchip finishes the write cycles on its own, allowing the MC68030 to continue with new cycles. If the SLVEN bit is cleared (slave disabled), the VMEchip acknowledges VME writes even before it has obtained VMEbus mastership. If the SLVEN bit is set, then it waits until it has obtained VMEbus mastership. This bit is cleared by SYSRESET.

Note The MC68030 is not notified via BERR* if an error occurs while the VMEchip is finishing a write posted cycle. The VMEchip can be programmed to interrupt the MC68030 if such an event occurs. Keep in mind that interrupt notification could be well after the occurrence of the error.

Bit 6 020 - This bit should always be cleared.

Bit 7 DDTACK - This bit should always be cleared for 25 MHz boards and set for 32 MHz boards.

Slave Configuration Register

The table below shows the slave configuration register.

Address	Bit7	Bit6	Bit5	Bit4	Bit 3	Bit 2	Bit 1	Bit 0
FFFE2007	SLVEN		SLVWP					SLVD16

Note The bits in the slave configuration must be changed only when the VMEchip has control of the VMEbus. The recommended procedure for changing the slave configuration is:

1. Set the DWB bit in the requester configuration register to 1.
2. Read the DHB status bit until it is 1.
3. Change the slave configuration register.
4. Clear the DWB bit to 0.

Bit 0 SLVD16 should always be cleared. Setting SLVD16 to 1 configures the VMEchip slave to provide only D08 (EO) and D16 data transfer capabilities. It is typically set when the local bus is only 16 bits wide. Clearing the SLVD16 bit to 0 configures the VMEchip slave to provide the D08 (EO), D16, and D32/UAT data transfer capabilities. This bit is cleared by SYSRESET.

- Bit 5** Setting the SLVWP bit speeds up VMEbus writes to the onboard DRAM. When SLVWP (slave write posting) is set, VMEbus write cycles to the onboard DRAM are acknowledged by the VMEchip before the data has been written into the DRAM. This allows the VMEbus master to end its cycle quickly, placing the burden on the VMEchip to complete the write to onboard DRAM on its own. This bit is cleared by SYSRESET.
- Bit 7** Setting SLVEN to 1 enables other VMEbus masters to access the MVME147S onboard DRAM. This bit is cleared by SYSRESET.

Timer Configuration Register

The table below shows the timer configuration register.

Address	Bit7	Bit6	Bit5	Bit4	Bit 3	Bit 2	Bit 1	Bit 0
FFFE2009		ARBT0	VBTO1	VBTO0	ACTO1	ACTO0	LBTO1	LBTO0

- Bits 0-1** These two bits configure the local time-out period. They are set to 1 by any reset.

LBTO1	LBTO0	Time-Out Period
0	0	102 microseconds
0	1	205 microseconds
1	0	410 microseconds
1	1	Timer disabled

The local bus timer activates bus error to the MC68030 when it tries to access nonexistent locations in the local memory map.

- Bits 2-3** These two bits configure the VMEbus access time-out period. They are set to 1 by any reset.

ACTO1	ACTO0	Time-Out Period
0	0	102 microseconds
0	1	1.6 millisecond
1	0	51 milliseconds
1	1	Timer disabled

The VMEbus access timer activates bus error to the MC68030 (except on write posted time-outs) when the VMEchip is unsuccessful in obtaining the VMEbus within the time-out period.

Bits 4-5 These two bits configure the VMEbus global time-out period. VBTO1 is set to 1 and VBTO0 is cleared to 0 by SYSRESET.

VBTO1	VBTO0	Time-Out Period
0	0	102 microseconds
0	1	205 microseconds
1	0	410 microseconds
1	1	Timer disabled

The VMEbus global timer activates BERR* on the VMEbus.

Bit 6 Setting ARBTO to 1 enables the VMEbus arbitration timer. The VMEbus arbitration timer activates BBSY* if it is not activated within 410 microseconds after the MVME147S arbiter issues a bus grant. The timer deactivates BBSY* as specified in the VMEbus specification. This causes the arbiter to arbitrate any pending requests for the bus. This bit is set to 1 by SYSRESET.

Slave Address Modifier Register

The table below shows the slave address modifier register.

ADDRESS	BIT 7	BIT 6	BIT 5	BIT 4	BIT 3	BIT 2	BIT 1	BIT 0
FFFE200B	SUPER	USER	EXTED	STND	SHORT	BLOCK	PRGRM	DATA

This register allows software to configure which address modifier codes for the VMEbus masters must use to access the onboard DRAM. The 8 bits of the register are organized into three groups. At least one of the bits in each group must be set, otherwise the address modifier used by the master is ignored.

- Bits 0-2** These three bits form the first group which configures the slave AM code. Setting any of the bits to one enables the slave to respond to cycles as described in the example below. Note BLOCK should never be set. These bits are cleared by SYSRESET.
- Bits 3-5** These three bits form the second group. Setting any of the bits to one enables the slave to respond to cycles as described in the example below. These bits are cleared by SYSRESET.
- Bits 6-7** These two bits form the third group. Setting any of the bits to one enables the slave to respond to cycles as described in the example below. These bits are cleared by SYSRESET.
- Example:** If the SUPER, STND, and DATA bits are set, then the only AM code accepted is \$3D, standard supervisor data access. When more than one bit is set in a group, the accepted AM codes include all permutations of the bits that are set. For example, if the SUPER, USER, EXTED, PRGRM, and DATA bits are set, the accepted AM codes are \$09, \$0A, \$0D, and \$0E. These are extended user data access, extended user program access, extended supervisor data access, and extended supervisor program access. The normal recommended configuration of the bits is all set except for BLOCK (\$FB).

Note Although all bits in the slave address modifier register may be changed dynamically, they must be changed only when the VMEchip has control of the VMEbus. The recommended procedure for changing the slave address modifier is:

1. Set the DWB bit in the requester configuration register to 1.
2. Read the DHB status bit until it is 1.
3. Change the slave address modifier register.
4. Clear the DWB bit to 0.

Master Address Modifier Register

The table below shows the master address modifier register.

Address	Bit7	Bit6	Bit5	Bit4	Bit 3	Bit 2	Bit 1	Bit 0
FFFE200D	AMSEL		AM5	AM4	AM3	AM2	AM1	AM0

The register allows software to program the address modifier code that is driven by the MVME147S during a VMEbus cycle.

Bits 0-5

These five bits, in conjunction with AMSEL, allow software to select dynamically the address space that the master accesses during VMEbus cycles. Setting any of these five bits to one causes the master to drive the corresponding address modifier line to high (if the AMSEL bit is set to 1).

Clearing any of the bits to 0 causes the master to drive the corresponding line to low (if the AMSEL bit is set to 1). These bits are cleared by SYSRESET.

Bit 7

Software uses the AMSEL control bit to define what is the source of the AM code driven by the master during a VMEbus cycle.

Setting the bit to 1 causes the master to drive the contents of the lower six bits onto the address modifier lines. No attempt is made to check the value stored in this register for reserved or illegal address modifiers.

Clearing the AMSEL bit causes the master to determine the AM code dynamically.

AMSEL should normally be cleared to 0. This bit is cleared by SYSRESET.

Interrupt Handler Mask Register

The table below shows the interrupt handler mask register.

Address	Bit7	Bit6	Bit5	Bit4	Bit 3	Bit 2	Bit 1	Bit 0
FFFE200F	IEN7	IEN6	IEN5	IEN4	IEN3	IEN2	IEN1	

This register is used to enable the MC68030 to respond to specific VMEbus interrupt requests. Note that the master interrupt enable bit in the PCC must also be set for VMEbus IRQs to get through to the MC68030.

Setting any of bits 1 through 7 unmask an interrupt request from the VMEbus IRQ signal at the corresponding level. Keep in mind that only one VMEbus master is allowed to handle each level of VMEbus IRQ. The software should set these bits accordingly. These bits are cleared by any reset.

Utility Interrupt Mask Register

The table below shows the utility interrupt mask register.

Address	Bit7	Bit6	Bit5	Bit4	Bit 3	Bit 2	Bit 1	Bit 0
FFFE2011	WPPERREN	SFIEN	SIGHEN	LM1EN	IACKEN	LM0EN	SIGLEN	

This register is used to enable the VMEchip interrupt handler to respond to specific utility interrupt requests. When the interrupt handler detects an interrupt request from one of the enabled functions, it responds by requesting the MC68030 to initiate an interrupt acknowledge cycle if the master interrupt enable bit is set in the PCC. All the bits in this register are cleared by any reset.

- Bit 1** As described in *Programming the GCSR* in this chapter, the GCSR provides two global attention interrupt bits: SIGLP and SIGHP, which allow other VMEbus masters to interrupt the MC68030 on a low priority (Level 1) and on a high priority (Level 5). Setting the SIGLEN control bit to 1 unmask the SIGLP interrupt.
- Bit 2** As described in *Programming the GCSR* in this chapter, the GCSR provides four location monitors. Two of them, location monitor 0 and 1, cause a local interrupt when the VMEbus address they are configured to monitor is accessed. The LM0EN control bit allows software to mask the interrupt requested when an access is detected to the address monitored by location monitor 0. The level of local interrupt is shown in the following table. Setting the LM0EN bit to 1 unmask the interrupt.
- Bit 3** The VMEchip allows software to program the interrupt handler to generate a local interrupt after it concludes a VMEbus IACK cycle. The level of the local interrupt is shown in the following table. Setting the IACKEN control bit to 1 enables the IACK interrupt.
- This function is intended to be coupled with the use of the VMEchip global interrupt function. If this bit is set, a local interrupt (to the MC68030) is generated when a VMEbus IACK cycle acknowledges the interrupt (refer to the *Interrupt Request Register* section in this chapter).
- Bit 4** As described in *Programming the GCSR* in this chapter, the GCSR provides four location monitors. Two of them, location monitor 0 and 1, cause a local interrupt when the VMEbus address they are configured to monitor is accessed. The LM1EN control bit allows software to mask the interrupt requested when an access is detected to the address monitored by location monitor 1. The level of local interrupt is shown in the following table. Setting the LM1EN bit to 1 unmask the interrupt.
- Bit 5** As described in *Programming the GCSR* in this chapter, the GCSR provides a global high priority attention interrupt bit SIGHP which allows other VMEbus masters to interrupt the MC68030. The level of the local interrupt is shown in the following table. Setting the SIGHEN control bit to 1 unmask the SIGHP interrupt.

- Bit 6** Setting SFIEN to 1 enables a low level on the VMEbus SYSFAIL* line to cause an interrupt to the MC68030. The level of the SYSFAIL* interrupt is shown in the table below.
- Bit 7** The VMEchip allows software to configure the VMEbus master to operate in a write posted mode (i.e., acknowledge the MC68030 VMEbus bound write cycle before it has actually been executed on the VMEbus). If the VMEchip encounters a VMEbus bus error as it attempts to complete the write posted cycle, the VMEchip notifies the MC68030 via Level 7 interrupt if the WPERREN bit is set.

Table 4-6. Utility Interrupts and Their Assigned Level

Utility Interrupt	Assigned Priority
SIGLP	Level 1
LM0	Level 2
IACK	Level 3
LM1	Level 4
SIGHP	Level 5
SYSFAIL	Level 6
WPBERR	Level 7

Utility Interrupt Vector Register

The table below shows the utility interrupt vector register.

Address	Bit7	Bit6	Bit5	Bit4	Bit 3	Bit 2	Bit 1	Bit 0
FFFE2013	UVB7	UVB6	UVB5	UVB4	UVB3	UID2	UID1	UID0

The utility interrupt vector register provides the local CPU with a unique vector for each of the utility interrupts.

Close examination reveals that the assigned level of each of the utility interrupts, as defined in *Utility Interrupt Mask Register*, is the same as its assigned ID. This is implemented by reflecting the state of the address lines A01-A03, that the local CPU drives when it acknowledges an interrupt, onto bits 0-2 of the utility vector register. When accessing this register in the course of a normal CPU read cycle, bit 0-2 yields the register offset value.

Note The contents of the utility interrupt vector register must not be changed while one of the utility interrupts is active.

Bits 0-2 The lower three bits of the utility interrupt vector register are encoded by the VMEchip to uniquely identify the function that caused the utility interrupt request as shown below.

Bits 3-7 UVB3 through UVB7 are utility vector base bits.

The upper five bits of the register are programmable by software to provide a unique base for the vector provided in the course of acknowledging one of the utility interrupts. These bits are cleared by any reset.

Table 4-7. Encoding of the Interrupt ID

Utility	Bit 2	Bit 1	Bit 0
SIGLP	0	0	1
LM0	0	1	0
IACK	0	1	1
LM1	1	0	0
SIGHP	1	0	1
SYSFAIL	1	1	0
WPBERR	1	1	1

Interrupt Request Register

The table below shows the interrupt request register.

Address	Bit7	Bit6	Bit5	Bit4	Bit 3	Bit 2	Bit 1	Bit 0
FFFE2015						IL2	IL1	IL0

This register is used to configure the interrupt request line that the interrupter activates to request an interrupt on the VMEbus.

Table 4-8. Configuring the Interrupt Request Level

Interrupt Request			
Line Driven	IL2	IL1	IL0
None	0	0	0
IRQ1*	0	0	1
IRQ2*	0	1	0
IRQ3*	0	1	1
IRQ4*	1	0	0
IRQ5*	1	0	1
IRQ6*	1	1	0
IRQ7*	1	1	1

Bits 0-2

The three interrupt level select lines are encoded as shown in the table above. Writing a nonzero value to these three bits causes the interrupter to activate the corresponding VMEbus IRQ line. Because the interrupter operates in the Release-On-Acknowledge (ROAK) mode, the interrupt request register is cleared, deactivating the IRQ line when the chip responds to a VMEbus interrupt acknowledge cycle. These bits are cleared by SYSRESET.

Note When the bits are set to drive one of the IRQ lines, they must not be changed. The three bits may be changed only when they are all cleared, signifying that the previous interrupt request has been serviced.

An added function provided by setting IACKEN (refer to *Utility Interrupt Mask Register*) is provided by the VMEchip to signal the local processor when the interrupt request (generated through this register) has been acknowledged on the VMEbus.

VMEbus Status/ID Register

The table below shows the VMEbus status/ID register.

Address	Bit7	Bit6	Bit5	Bit4	Bit 3	Bit 2	Bit 1	Bit 0
FFFE2017	D07	D06	D05	D04	D03	D02	D01	D00

This register allows software to program dynamically the status/ID that the interrupter provides during an interrupt acknowledge cycle. D00-D03 are set by SYSRESET, D04-D07 are cleared by SYSRESET.

Bus Error Status Register

The table below shows the bus error status register.

Address	Bit7	Bit6	Bit5	Bit4	Bit 3	Bit 2	Bit 1	Bit 0
FFFE2019					RMCERR	VBERR	ACTO	LBTO

This register allows the MC68030 to determine the cause of a bus error condition flagged by the VMEchip. Reading the register causes all of its bits to be cleared to 0. The bus error status register is designed to only indicate the cause of the latest bus error condition (for instance when there is cause to set any of the bits, all other bits are cleared).

- Bit 0** When set, this status bit indicates that the local timer has timed out.
- Bit 1** When set, this status bit indicates that the VMEbus access timer has timed out.
- Bit 2** When set, this status bit indicates that the VMEbus BERR* signal was activated in the course of a non write posted cycle that was initiated by the VMEchip. It should be noted that this bit is not set if the VMEbus global timer timed out in response to a VMEbus cycle that was initiated by another VMEbus master.
- Bit 3** This bit should be ignored.

GCSR Base Address Configuration Register

The table below shows the GCSR base address configuration register.

Address	Bit7	Bit6	Bit5	Bit4	Bit 3	Bit 2	Bit 1	Bit 0
FFFE201B					GCSRA7	GCSRA6	GCSRA5	GCSRA4

This register allows software to set the base address of the GCSR set in the VMEbus supervisor short I/O map.

The value contained in bits 0-3 of this register configures bits 4-7 of the GCSR base address. Address lines A08-A15 are fixed at \$0. Refer to the table below. Bits 1-3 of the VMEbus address select the specific registers in the GCSR. These bits are set to 1 by SYSRESET, therefore, unless otherwise programmed, the GCSR set does not respond to VMEbus accesses. GCSR functions are not enabled when the GCSR is mapped not to respond to VMEbus accesses. For example: location monitors SIGHP and SIGLP.

Table 4-9. VMEchip GCSR as Viewed from the VMEbus

GCSRA7-4	Short I/O Address of GCSR
\$0	\$0000-000F
\$1	\$0010-001F
\$2	\$0020-002F
\$3	\$0030-003F
\$4	\$0040-004F
\$5	\$0050-005F
\$6	\$0060-006F
\$7	\$0070-007F
\$8	\$0080-008F
\$9	\$0090-009F
\$A	\$00A0-00AF
\$B	\$00B0-00BF
\$C	\$00C0-00CF
\$D	\$00D0-00DF
\$E	\$00E0-00EF
\$F	Does not respond

Programming the GCSR

There are eight GCSR registers as shown in the following table.

Table 4-10. VMEchip GCSR

MVME147S	VMEbus								
Address	Address	Bit 7	Bit 6	Bit 5	Bit 4	Bit 3	Bit 2	Bit 1	Bit 0
FFFE201	00X1	LM3	LM2	LM1	LM0	CHIPID3	CHIPID2	CHIPID1	CHIPID0
FFFE203	00X3	R&H	SCON	ISF	BRD FAIL			SIGHP	SIGLP
FFFE205	00X5	BRDID7	BRDID6	BRDID5	BRDID4	BRDID3	BRDID2	BRDID1	BRDID0
FFFE207	00X7	General Purpose Control and Status Register 0							
FFFE209	00X9	General Purpose Control and Status Register 1							
FFFE202B	00XB	General Purpose Control and Status Register 2							
FFFE202D	00XD	General Purpose Control and Status Register 3							
FFFE202F	00XF	General Purpose Control and Status Register 4							

NOTE: X denotes the value in the GCSR base address configuration register bits 0-3.

Global Register 0

The table below shows the global register 0.

MVME147S	VMEbus								
ADDRESS	ADDRESS	BIT 7	BIT 6	BIT 5	BIT 4	BIT 3	BIT 2	BIT 1	BIT 0
FFFE201	00X1	LM3	LM2	LM1	LM0	CHIPID3	CHIPID2	CHIPID1	CHIPID0

Bits 0-3 These bits provide a unique identification number for the VMEchip. The VMEchip presents a hardwired ID of %0001.

Bit 4 (NOTE) Location monitor 0 is configured to monitor double-byte accesses to the supervisor short I/O address \$00F0, and single-byte accesses to the short I/O address \$00F1. When cleared, LM0 indicates that an access to address \$00F0 or \$00F1 was detected. At such a time, utility interrupt level 2 is requested (if the interrupt is enabled). LM0 is set when the interrupt is acknowledged or when software writes a 1 to it. This bit is set to 1 by SYSRESET.

Bit 5 (NOTE) Location monitor 1 is configured to monitor double-byte accesses to the supervisor short I/O address \$00F2, and single-byte accesses to the short I/O address \$00F3. When cleared, LM1 indicates that an access to address \$00F2 or \$00F3 was detected. At such a time, utility interrupt level 4 is requested (if the interrupt is enabled). LM1 is set when the interrupt is acknowledged or when software writes a 1 to it. This bit is set to 1 by SYSRESET.

Bit 6 (NOTE) Location monitor 2 is configured to monitor double-byte accesses to the supervisor short I/O address \$00F4, and single-byte accesses to the short I/O address \$00F5. When cleared, LM2 indicates that an access to address \$00F4 or \$00F5 was detected. LM2 is set when software writes a 1 to it. This bit is set to 1 by SYSRESET.

Bit 7 (NOTE) Location monitor 3 is configured to monitor double-byte accesses to the supervisor short I/O address \$00F6, and single-byte accesses to the short I/O address \$00F7. When cleared, LM3 indicates that an access to address \$00F6 or \$00F7 was detected. LM3 is set when software writes a 1 to it. This bit is set to 1 by SYSRESET.

Note The GCSR set must respond to VMEbus accesses for this function to be enabled. The MVME147S module that executes the location monitor cycle generates the DTACK which terminates the cycle.

Global Register 1

The table below shows the global register 1.

MVME147S	VMEbus								
Address	Address	Bit7	Bit6	Bit5	Bit4	Bit 3	Bit 2	Bit 1	Bit 0
FFFE2023	00X3	R&H	SCON	ISF	BRD FAIL			SIGHP	SIGLP

Bit 0 The SIGLP control signal allows other VMEbus masters to interrupt the MC68030. SIGLP can only be set from the VMEbus. It can only be cleared by the MC68030. When a VMEbus master sets SIGLP to a 1, the VMEchip requests a level 1 interrupt to the MC68030 (if such interrupts are enabled). The interrupt request remains until the MC68030 writes a 1 to it. This bit is cleared by SYSRESET. The GCSR set must respond to VMEbus accesses for this function to be enabled.

- Bit 1** The SIGHP control signal allows other VMEbus masters to interrupt the MC68030. SIGHP can only be set from the VMEbus. It can only be cleared by the MC68030. When a VMEbus master sets SIGHP to a 1, the VMEchip requests a level 5 interrupt to the MC68030 (if such interrupts are enabled). The interrupt request remains until the MC68030 writes a 1 to it. This bit is cleared by SYSRESET. The GCSR set must respond to VMEbus accesses for this function to be enabled.
- Bit 4** BRDFAIL is a reflection of the BRDFAIL* input/output signal line. The status bit is set to 1 whenever the signal line is activated by either the VMEchip, or by a watchdog timeout from the PCC. The bit is cleared when the BRDFAIL* signal is deactivated.
- Bit 5** The ISF control bit allows other VMEbus masters to cause the VMEchip to release its contribution to the VMEbus SYSFAIL* line. This is provided so that software can determine how many boards have failed. It should be noted that the ISF bit has no effect on the BRDFAIL status bit. Setting the bit to 1 inhibits the VMEchip from activating the VMEbus SYSFAIL* line. This bit is cleared by SYSRESET.
- Bit 6** The SCON status bit is a reflection of the configuration of header J3. When J3 pins 1 and 2 are connected, enabling the MVME147S as system controller, the SCON bit is 1. Otherwise it is 0.
- Bit 7** The R&H bit allows other VMEbus masters to reset the MVME147S. The MVME147S is held in the reset state for as long as the R&H bit is set. This bit is cleared by SYSRESET.

Note If the MVME147S sets its own R&H bit, it causes itself to be maintained in a reset state until some other master clears the bit to 0.

Software must never activate R&H for shorter than 35 microseconds.

This bit should not be set while the local MPU is executing a VMEbus cycle. Board Identification Register

The table below shows the board identification register.

MVME147S	VMEbus								
Address	Address	Bit7	Bit6	Bit5	Bit4	Bit 3	Bit 2	Bit 1	Bit 0
FFFE2025	00X5	BRDID7	BRDID6	BRDID5	BRDID4	BRDID3	BRDID2	BRDID1	BRDID0

The MC68030 can both read and write to this register. The VMEbus can only read it. This register allows the software to uniquely identify boards. The whole register is cleared by SYSRESET.

General Purpose CSR 0

The table below shows the general purpose CSR 0.

MVME147S	VMEbus								
Address	Address	Bit7	Bit6	Bit5	Bit4	Bit 3	Bit 2	Bit 1	Bit 0
FFFE2027	00X7	General Purpose Control and Status Register 0							

General purpose CSR 0 is both readable and writable from the MC68030 and from the VMEbus. All of its bits are set to 1 at SYSRESET.

General Purpose CSR 1-4

The table below shows the general purpose CSR 1-4.

MVME147S	VMEbus								
Address	Address	Bit7	Bit6	Bit5	Bit4	Bit 3	Bit 2	Bit 1	Bit 0
FFFE2029	00X9	General Purpose Control and Status Register 1							
FFFE202B	00XB	General Purpose Control and Status Register 2							
FFFE202D	00XD	General Purpose Control and Status Register 3							
FFFE202F	00XF	General Purpose Control and Status Register 4							

General purpose CSR 1-4 are both readable and writable from the MC68030 and from the VMEbus. All of their bits are cleared to 0 at SYSRESET.

Introduction

This chapter provides the functional description of the MVME147S at block level. The functional description provides an overview of the module, followed by a detailed description of each section of the module. The block diagram of the MVME147S is shown in *MVME147S Block Diagram*.

Functional Description

The MVME147S is a complete microcomputer system. The module contains a MC68030 MPU, 4MB, or more of DRAM (accessible from the VMEbus), a MC68882 Floating-Point Coprocessor, VMEchip, 2040 bytes of static RAM (with battery backup), time-of-day clock (with battery backup), four serial ports with RS-232C interface, two tick timers, watchdog timer, four ROM sockets, SCSI bus interface with DMA, Ethernet transceiver interface, Centronics printer port, A32/D32 VMEbus interface, and VMEbus system controller as well as numerous control functions. The Ethernet interface is not included on the MVME147SRF.

MC68030 MPU

The MC68030 is the main processor of the MVME147S. The MC68030 has onchip instruction and data caches. The MVME147S prevents the MC68030 from caching accesses to any other device than local DRAM by activating the cache inhibit in pin during the accesses. Also note that cache bursting by the MC68030 is not a supported feature of the MVME147SA-2, the MVME147SB-2, or the MVME147SC-2. If software sets the burst enable bits in the MC68030 CACR, the MC68030 requests cache bursting, but the request is ignored and all cycles are run as single cycles. The MC68030 includes a software reset instruction. The MVME147S does not support this instruction. Refer to the *MC68030 Enhanced 32-Bit Microprocessor User's Manual*.

MC68882 FPC

The MC68882 Floating-Point Coprocessor (FPC) is connected to the MC68030 as a 32-bit port. It runs at the same frequency as the MC68030. If the MC68882 chip is removed, attempts to access it result in an F-line exception (no Bus Error (BERR) status bits are set). Refer to the *MC68881/MC68882 Floating-Point Coprocessor User's Manual* for a detailed description of its operation.

5

VMEchip

The VMEchip is an Application Specific IC (ASIC) device designed to reduce the real estate required to interface with the VMEbus. It provides the VMEbus system controller functions, VMEbus interrupt handler, VMEbus and local time-out functions, MC68030 to VMEbus interface, and VMEbus control signal drivers and receivers.

VMEbus System Controller

One of the many functions provided by the VMEchip is the VMEbus system controller function. The system controller includes the VMEbus global time-out timer, System Clock (SYSCLK*) driver, arbiter, and Interrupt Acknowledge (IACK*) daisy-chain driver. The system reset utility is also described here because it is enabled when the MVME147S is system controller. The system controller function is enabled/disabled by header J3. When the MVME147S is system controller, the System Controller (SCON) LED is turned on.

VMEbus Time-Out

The VMEbus timer is started when either Data Strobe (DS0* or DS1*) goes active and is disabled when they both go inactive. If the timer times out before the data strobes go inactive, the Bus Error (BERR*) signal is activated. The time-out period is controlled by the timer interval register and may be 102 μ s, 205 μ s, 410 μ s, or infinite.

System Clock Utility

The 16 MHz system clock is driven onto the VMEbus SYSCLK* signal line by the VMEchip system clock driver.

Arbiter

The VMEchip implements two different arbitration modes. They are prioritized and round-robin. The mode is software selectable.

In the prioritized mode, the arbiter prioritizes the bus request signals and responds with grant to the highest priority requester. The arbiter also informs the current bus master by activating the Bus Clear (BCLR*) signal when a request from a higher priority master has been received.

In the round-robin mode, the arbiter assigns the bus on a rotating priority basis. The BCLR* signal is not used in the round-robin mode.

The arbiter also contains a time-out feature. It activates Bus Busy (BBSY*) on its own if BBSY* is not activated by the requester within the time-out period. The time-out period is software selectable and may be set to 410 s or infinite.

IACK* Daisy-Chain Driver

The IACK* daisy-chain driver activates the interrupt acknowledge daisy-chain whenever an interrupt handler acknowledges an interrupt request.

System Reset Function (SYSRESET*)

Even though SYSRESET* is not a VMEbus system controller function, the MVME147S enables/disables its SYSRESET* function at the same time that it enables/disables its system controller functions. When the MVME147S is system controller, it drives the SYSRESET* signal line whenever an onboard reset is generated (it does not fully implement the SYSRESET* timing of a VMEbus power monitor).

VMEbus Interrupter

The VMEchip incorporates a flexible, multilevel bus interrupter module. This module can activate an interrupt on the VMEbus at any of the seven interrupt levels.

The VMEchip interrupter also monitors the VMEbus to determine when an interrupt acknowledge cycle is in process. When the VMEchip receives an interrupt-acknowledge-in signal from the VMEbus and it is currently interrupting at the acknowledge level, it responds with a status/id vector. Otherwise, it generates an interrupt-acknowledge-out signal to the VMEbus. The VMEchip is a 8-bit interrupter and consequently responds to all sizes of interrupt acknowledge cycles.

Local Bus Time-Out

The VMEchip provides a time-out function for the MC68030 local bus. When the timer times out, a bus error signal is sent to the MC68030. The time-out value is selectable in software for 102 μ s, 205 μ s, 410 μ s, or infinite.

Note The local bus timer does not operate during VMEbus bound cycles. VMEbus bound cycles are timed by the VMEbus access timer as discussed in *VMEbus Access Time-Out* and by the global timer (not necessarily on the module).

VMEbus Access Time-Out

The VMEchip provides a VMEbus access time-out timer. If the MVME147S is not granted the VMEbus within the selected time period, the MC68030 receives a bus error signal (unless the cycle is write posted). The time period is selectable in software for 102 μ s, 1.6 μ s, 51 μ s, or infinite.

VMEbus Master Interface

The VMEbus master interface is provided by the VMEchip. Depending on the VMEbus address, the MVME147S master interface may be A32/D32, A24/D16, or A16/D16. When the MC68030 needs the VMEbus for a read,

write, read-modify- write, or interrupt acknowledge cycle, it requests the VMEchip to obtain bus mastership. The VMEchip requests the bus and after it receives mastership, it activates the VMEbus signals as requested by the MC68030. When the slave responds, the VMEchip passes this information to the MC68030.

VMEbus Requester

The VMEbus requester is used to obtain and relinquish mastership of the VMEbus. Its operation is affected by software programmable bits in the VMEchip.

The requester requests VMEbus mastership at the programmed level when the board is not the current VMEbus master and one of the following happens:

- ❑ The MC68030 executes a program space cycle that is bound for the VMEbus
- ❑ The MC68030 executes a data space cycle that is bound for the VMEbus
- ❑ The MC68030 executes an IACK cycle that is bound for the VMEbus
- ❑ The MC68030 sets the DWB bit in the VMEchip
- ❑ The MC68030 executes a “multiple address RMC” cycle that is bound for the local DRAM and the WAITRMC bit is set in the PCC

Requesting VMEbus mastership is also affected by the RONR bit in the VMEchip LCSR.

The requester maintains VMEbus mastership as long as one of the following conditions is met:

- ❑ The MC68030 is executing a VMEbus cycle
- ❑ The RWD bit is cleared in the VMEchip and no other VMEbus master is activating a bus request
- ❑ The RNEVER bit is set in the VMEchip
- ❑ The DWB bit is set in the VMEchip
- ❑ The MC68030 is performing an RMC sequence to the VMEbus
- ❑ The MC68030 is finishing an RMC sequence that started in local DRAM while the WAITRMC bit was set in the PCC

VMEbus Slave Interface

The VMEchip provides the VMEbus slave interface for the MVME147S. When the VMEbus wants to access the DRAM or VMEchip control registers, the VMEbus map decoder selects the VMEchip. For a DRAM access, the VMEchip requests the local bus and after obtaining mastership, the VMEchip activates the proper signals to access the DRAM. The DRAM notifies the VMEchip and the VMEchip notifies the VMEbus when the DRAM has completed. Mastership of the local bus is not required to access the VMEchip Global Control and Status Registers. The VMEbus cannot access any other resources than DRAM on the MVME147S.

Peripheral Channel Controller (PCC)

The PCC is an ASIC designed device for the MVME147S to allow the required functions to fit on a VMEbus double-high form factor board. The PCC includes the following features:

- ❑ DMA channel for SCSI data
- ❑ 8-bit to 32-bit converter for SCSI data
- ❑ SCSI chip interface
- ❑ Local processor interrupter/handler

- ❑ Peripheral chip map decoder
- ❑ Two programmable tick timers
- ❑ Watchdog timer.
- ❑ Parallel (Centronics) printer interface
- ❑ Control and status registers
- ❑ RESET and ABORT switch interface
- ❑ Power up reset interface
- ❑ AC Fail interrupter
- ❑ Refresh timer for local DRAM

DMA Channel Controller

The PCC includes a DMA Channel Controller (DMAC) to move data between the SCSI chip and memory. The DMA channel features a 32-bit address pointer for data transfers, a 32-bit pointer for the command chaining table, and a 24-bit byte counter. Because of its 8-bit to 32-bit data bus width conversion, the chip moves SCSI data at rates up to 1.5MB/second while using less than 25 percent of the local bus bandwidth when doing a DMA to local DRAM.

DMAC Initiation Mode

The DMAC has two initiation modes: direct and command chaining (scatter- gather). In the direct mode, the data address pointer and the byte count are loaded into the chip. In the command chaining mode, a table of data addresses and byte counts is placed in local RAM and the address of the table is loaded into the chip. The chip walks through the addresses and byte counts from the local RAM to move each block of data as indicated by the table. Scatter- gather operations are supported by command chaining. The PCC can DMA to/from local DRAM and VMEbus memory only. Any other access results in local bus time- out.

DMAC Operation States

The DMAC is always in one of three operational states: idle state, table walk state, or data transfer state. The DMA sequences through the three depending upon the contents of the DMA control register which is initialized by the MPU.

Idle State

5

The DMAC starts out from reset in the idle state. It stays in the idle state until the DMAC is enabled (DMAEN set to 1). It returns to the idle state when the DMAC has completed the requested operations (normally or with error). It does not leave the idle state again until all error status bits are cleared and DMAEN is again set to 1.

Data Transfer State

When DMAEN is set, the DMAC goes directly to the data transfer state unless the Table Walk (TW) bit is set. If TW is set, the DMAC table walks before entering the data transfer state. In either event, when the data transfer state is entered, the DMAC moves data between local DRAM and the WD33C93 (SCSI bus interface controller). The DMAC reads/writes data in local DRAM using the address contained in the data address register. Data transfers continue until the byte count register reaches 0. At this point, the DMAC sets the done bit and enters the idle state unless more table walking is indicated by the link bit in the byte count register.

Table Walk State

The table address and table function code registers point to the table. The following table shows a sample table. The table has two entries for each data block: the data address and the byte count. When the DMAC table walks, it copies the first longword from the table into the table address register, and the second longword from the table into the byte count register. It then goes to the data transfer state. If the table walk caused the link bit to be set, the DMAC table walks again after the data transfer state has ended.

Note The DMAC table must always be placed within 32-bit memory. The PCC terminates if 8-bit or 16-bit memory is encountered during a table walk.

Table 5-1. Example DMA Table

Memory Address	Data	Comments
\$00010000	\$00020000	The first block of data starts at \$20000
\$00010004	\$85000100	There are more entries, FC's = 5, move \$100 bytes
\$00010008	\$00128000	The second block of data starts at \$128000
\$0001000C	\$83001000	There are more entries, FC's = 3, move \$1000 bytes
\$00010010	\$00045000	The third block of data starts at \$45000
\$00010014	\$03000050	There are no more entries, FC's = 3, move \$50 bytes

DMAC Error Conditions

If any error is encountered during the table walk or the data transfer state, the DMAC goes immediately to the idle state. In addition, it sets the done bit and the appropriate error bit.

SCSI Data Bus Converter

The WD33C93 connects to a separate 8-bit data bus on the PCC and not to the local MC68030 bus. This allows the PCC to collect one longword of data by transferring one byte at a time from the WD33C93 without using the processor bus. When a longword is ready, the chip requests the local bus and transfers it. This scheme lightens the load on the MC68030 local bus.

SCSI Reset

Because the WD33C93 does not implement SCSI bus Reset (RST), the PCC has separate signals to sense and drive it.

SCSI Chip Interface

The PCC provides the interface for MC68030 accesses of the WD33C93. It uses the nonmultiplexed mode which requires that the software use the WD33C93 pointer registers to access its internal registers. The WD33C93 registers are accessible indirectly through the address register at \$FFFE4000.

Programmable Tick Timers

The PCC features two 16-bit programmable tick timers. A timer generates a periodic interrupt to the MC68030 at the programmed rate. The period is 6.25 μ s to 0.4 seconds in 6.25 μ s increments. The timer may also be disabled. The timer interrupt level is programmable and it provides a status/id vector when its interrupt is acknowledged.

Watchdog Timer

The PCC includes a watchdog timer function. When enabled by software, the watchdog timer may be programmed to reset the module if it is system controller. Whenever the watchdog timer times out, the FAIL LED is lit (in addition to when the BRDFAIL bit is set in the VMEchip). The watchdog timer counts outputs from tick timer 1. If the watchdog timer is not reset by software within the programmed number of ticks, it times out.

Printer Interface

The PCC has a Centronics compatible printer interface. The printer interface interrupts the MC68030 when it is ready for data or when a fault occurs. The interrupt level is programmable and it provides a status/id vector when requested.

Control and Status Registers

The PCC has input and output signal lines for controlling various functions on the MVME147S. There are control lines for DRAM parity enable, parity test and parity error status, VMEbus map select, multiple address RMC mode, and LANCE address select.

RESET and ABORT Switches

The PCC provides the RESET and ABORT switch interface. The RESET switch signal is debounced and when it is enabled, it causes a reset out signal. The RESET switch can be enabled/disabled by software.

The ABORT switch signal is debounced and sent to the level 7 interrupter. When it is enabled, the ABORT switch causes a level 7 interrupt to the MC68030. The interrupter returns a status/id vector when requested. The ABORT switch can be enabled/disabled by software.

Power Up Reset

When the PCC receives a power up reset signal, it generates a reset out signal and sets the power up bit in the control register. The power up bit can be used by software to determine when a power up reset has occurred.

AC Fail Interrupter

When the AC Fail interrupt is enabled and the PCC receives an AC Fail signal, a Level 7 interrupt is sent to the MC68030. The AC Fail interrupt can be enabled/disabled by software. The AC Fail interrupter provides a status/id vector when requested.

RAM Refresh Timer

The DRAM used on the MVME147S must be refreshed every 8 ms. Because there are 512 rows, a row must be refreshed every 15.6 μ s. The PCC provides a refresh signal to the DRAM at least once every 15.6 μ s.

Serial Port Interface

The MVME147S uses two Z8530 Serial Communications Controller (SCC) devices to implement the four serial ports. The 5 MHz P clock is used to generate the baud rate clock and the serial ports support the standard baud rates (110 through 19,200). Serial port 4 also supports synchronous modes of operation.

The four serial ports on the MVME147S are different functionally because of the limited number of pins on the P2 connector. Serial port 1 is a minimum function asynchronous port. It uses RXD, CTS, TXD, and RTS. Serial ports 2 and 3 are full function asynchronous ports. They use RXD, CTS, DCD, TXD, RTS, and DTR. Serial port 4 is a full function asynchronous or synchronous port. It uses RXD, CTS, DCD, TXD, RTS, and DTR. It also interfaces to the synchronous clock signal lines.

All four serial ports use RS-232C drivers and receivers located on the MVME147S and all the signal lines are routed to P2. The configuration headers are located on the MVME147S and the MVME712. An external I/O transition board such as the MVME712 must be used to convert the P2 pin out to industry standard connectors.

Headers on the MVME712 provide jumper selectable options for each RS-232C interface to be configured to connect to DTE or DCE.

For additional information on the SCCs, refer to the Zilog literature listed in [Related Specifications](#).

Ethernet Interface

The Ethernet interface is not used on the MVME147SRF.

The MVME147S uses the AM7990 Local Area Network Controller for Ethernet (LANCE) and the AM7992 Serial Interface Adapter (SIA) to implement the Ethernet transceiver interface. The balanced differential transceiver signal lines from the AM7992 are coupled via an onboard transformer to signal lines that go to P2 and eventually to the MVME712 transition board where they are connected to an industry standard DB-15 connector.

The AM7990 performs DMA operations to perform its normal functions. The MVME147S restricts AM7990 DMA to local DRAM only. The AM7990 cannot access the VMEbus. If the DRAM size is less than 16MB then it repeats itself in the AM7990 16MB memory map. If it is more than 16MB, then the AM7990 accesses the section of DRAM defined by the LANA24 and LANA25 bits in the PCC RAM base register (bits 6 and 7 of \$FFFE102B).

Every MVME147S is assigned an Ethernet station address. The address is \$08003E2XXXXX where XXXXX is the unique number assigned to the module (every MVME147S has a different value for XXXXX).

Each Ethernet station address is displayed on a label attached to the back of the MVME147S front panel. In addition, the XXXXX portion of the Ethernet station address is stored in BBRAM, location \$FFFE0778 as \$2XXXXX.

If Motorola networking software is running on an MVME147S, it uses the 2XXXXX value from BBRAM to complete the Ethernet station address (\$08003E2XXXXX). The user must assure that the value of 2XXXXX is maintained in BBRAM. If the value of 2XXXXX is lost in BBRAM, the user should use the number on the front panel label to restore it. Note that MVME147Sbug includes the “LSAD” command for examining and updating the BBRAM XXXXX value.

If non-Motorola networking software is running on an MVME147S, it must set up the 7990 so that the Ethernet station address is that shown on the front panel label to ensure that the module has a globally unique Ethernet station address.

SCSI Interface

The MVME147S has a SCSI mass storage bus interface. The SCSI bus is provided to allow mass storage subsystems to be connected to the MVME147S. These subsystems may include hard and floppy disk drives, streaming tape drives, and other mass storage devices. The SCSI interface is implemented using the WD33C93 controller. DMA to/from the WD33C93 is implemented through the PCC.

Data Bus Structure

The data bus structure on the MVME147S is arranged to accommodate the 8-bit, 16-bit, 32-bit, and 16/32-bit ports that reside on the board. The 8-bit ports are connected to D24-D32 of the local bus, 16-bit ports are connected to D16- D32 of the local bus and 32-bit ports are connected to D00-D32 of the local bus.

Battery Backed Up RAM and Clock

The Mostek MK48T02 RAM and clock chip is used on the MVME147S. This chip provides a time-of-day clock, oscillator, crystal, power fail detection, memory write protection, 2040 bytes of RAM, and a battery in one 24-pin package. The clock provides seconds, minutes, hours, day, date, month, and year in BCD 24-hour format. Corrections for 28, 29 (leap year) and 30 day months are automatically made. No interrupts are generated by the clock. The internal battery has a typical life span of 3 to 5 years when the clock is running and a minimum of 10 years when the clock has not been put in operation.

ROM/PROM/EPROM/EEPROM

There are four 32-pin ROM/PROM/EPROM/EEPROM sockets on the MVME147S. They are organized as 2 banks with two sockets per bank. The banks are configured as word ports to the MPU. Each bank can be separately configured for 8K x 8, 16K x 8, 32K x 8, 64K x 8, 128K x 8, 256K x 8, 512K x 8, or 1M x 8 ROM/PROM/EPROM devices or 2K x 8, 8K x 8, or 32K x 8 EEPROM devices.

There are several different algorithms for erasing/writing to EEPROM devices depending on the manufacturer. The MVME147S supports only those devices which have a static RAM compatible erase/write mechanism such as the Xicor X28256 or X2864H.

Device Timing Requirements

The ROM/PROM/EPROM/EEPROM devices must meet the timings shown in [Figure 5-1](#). The ROM/PROM/EPROM/EEPROM devices are guaranteed the timings shown in [Figure 5-2](#).

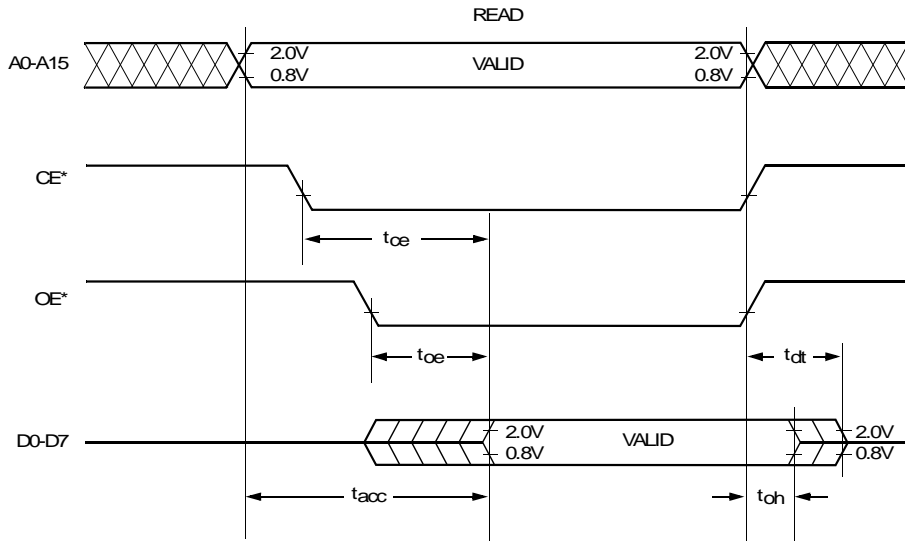

SYMBOL	DESCRIPTION	MIN	MAX	UNIT
t _{acc}	Address valid to data valid.		250	ns
t _{oe}	CE* low to data valid.		250	ns
t _{oe}	OE* low data valid.		250	ns
t _{oh}	Address invalid, CE* or OE* high to data not valid.	0		
t _{dt}	CE* or OE* high to data high impedance.		100	ns

2728 0004

Figure 5-1. Timings Required by the MVME147S

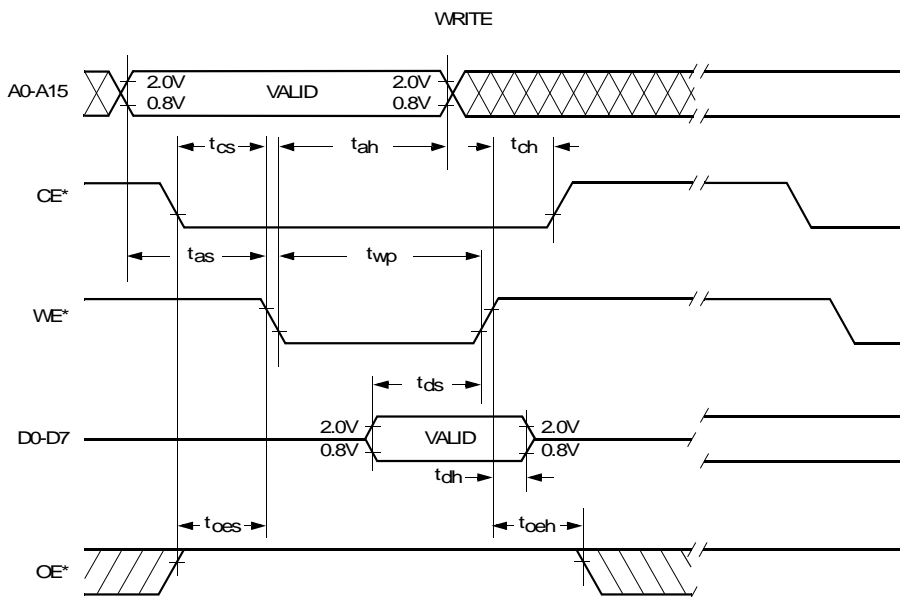

SYMBOL	DESCRIPTION	MIN.	MAX.	UNIT
t_{as}	Address valid to WE* low.	50		ns
t_{cs}	CE* low to WE* low.	50		ns
t_{oes}	OE* high to WE* low.	70		ns
t_{ah}	Address invalid after WE* low.	200		ns
t_{wp}	WE* low pulse width.	190		ns
t_{ds}	Data valid to WE* high.	160		ns
t_{ch}	WE* high to data not valid.	5		ns
t_{oeh}	WE* high to OE* low.	100		ns
t_{ch}	WE* high to CE* high.	10		ns

2729 0003

Figure 5-2. Timings Guaranteed by MVME147S #ti299202

EEPROM Power Up/Power Down Considerations

The MVME147S provides no protection against inadvertent writes to EEPROM that might happen at power up or power down time. Most devices provide some level of internal protection. To gain “absolute protection” devices with additional “software protection” are recommended.

Interrupt Handler

The MC68030 may be interrupted by many sources. All interrupt sources are software enabled/disabled. Some have software programmable levels and all interrupt sources supply a vector during an interrupt acknowledge cycle.

The PCC chip decodes the MC68030 address bus and function codes to determine when an interrupt cycle is in progress. When the PCC detects an interrupt acknowledge cycle at the level it is interrupting on, it passes a status/id vector. Otherwise, it generates an interrupt acknowledge out signal to the VMEchip. When the VMEchip detects an interrupt acknowledge in signal from the PCC and it is interrupting at that level, it passes a status/id vector. Otherwise, it requests mastership of the VMEbus (if it does not have mastership), and it drives the VMEbus signal lines to initiate an interrupt acknowledge cycle. The interrupting slave returns a status/id vector.

Within a level, the interrupts from the PCC have the highest priority followed by the VMEchip and the VMEbus interrupts have the lowest priority.

Interrupt sources and vectors are listed in the following table.

Table 5-2. MVME147S Interrupt Sources and Vectors

Interrupt Source	Path	Vector Source	Vector	Level
ACFAIL	PCC	PCC	%XXXX0000	7
BERR	PCC	PCC	%XXXX0001	7
ABORT	PCC	PCC	%XXXX0010	7
Serial Ports	PCC	Z8530 devices	See Z8530 Data Sheet	Prog

Table 5-2. MVME147S Interrupt Sources and Vectors

Interrupt Source	Path	Vector Source	Vector	Level
	PCC	PCC	%XXXX0011	Prog
LANCE	PCC	PCC	%XXXX0100	Prog
SCSI Port	PCC	PCC	%XXXX0101	Prog
SCSI DMA	PCC	PCC	%XXXX0110	Prog
Printer Port	PCC	PCC	%XXXX0111	Prog
Tick Timer (1)	PCC	PCC	%XXXX1000	Prog
Tick Timer (2)	PCC	PCC	%XXXX1001	Prog
Software int (1)	PCC	PCC	%XXXX1010	Prog
Software int (2)	PCC	PCC	%XXXX1011	Prog
WPBERR	VMEchip	VMEchip	%YYYYY111	7
SYSFAIL	VMEchip	VMEchip	%YYYYY110	6
SIGHP	VMEchip	VMEchip	%YYYYY101	5
LM1	VMEchip	VMEchip	%YYYYY100	4
IACK	VMEchip	VMEchip	%YYYYY011	3
LM0	VMEchip	VMEchip	%YYYYY010	2
SIGLP	VMEchip	VMEchip	%YYYYY001	1
VMEbus IRQ7*	VMEchip	From interrupting VMEbus slave	Determined by VMEbus slave	7
VMEbus IRQ6*	VMEchip	Same as above	Same as above	6
VMEbus IRQ5*	VMEchip	Same as above	Same as above	5
VMEbus IRQ4*	VMEchip	Same as above	Same as above	4
VMEbus IRQ3*	VMEchip	Same as above	Same as above	3
VMEbus IRQ2*	VMEchip	Same as above	Same as above	2
VMEbus IRQ1*	VMEchip	Same as above	Same as above	1
Notes:				
1.	XXXX is the value programmed into the PCC interrupt vector register (address \$FFFE102D) bits 4 through 7.			
2.	YYYYY is the value programmed into the VMEchip interrupt vector register (address \$FFFE2013) bits 3 through 7.			

Front Panel Switches and Indicators

There are two switches on the front panel of the MVME147S. The switches are RESET and ABORT. The RESET switch resets all onboard devices and drives SYSRESET* if the MVME147S is the system controller. The RESET switch may be disabled by software. Refer to the *RESET and ABORT Switches* in this chapter.

The ABORT switch generates a Level 7 interrupt when enabled. It is normally used to abort program execution and return to the debugger. The ABORT switch may be disabled by software. Refer to the *RESET and ABORT Switches* in this chapter.

There are four LED indicators on the front panel of the MVME147S. The indicators are RUN, STATUS, FAIL, and SCON. RUN is lit when the MC68030 Address Strobe (AS*) pin is low. STATUS is lit when the MC68030 STATUS* pin is low. FAIL is lit when the Board Fail (BRDFAIL) bit is set in the VMEchip or when watchdog time-out occurs in the PCC. SCON is lit when the MVME147S is the VMEbus system controller.

Onboard DRAM

The DRAM is accessible by the MC68030, PCC, LANCE, and VMEbus. It is specifically optimized for the MC68030.

The parity feature is not implemented on the MVME147SRF.

The MVME147S has parity check which operates in one of three user selectable modes. In mode 1, no parity checking is performed and the DRAM operates at maximum speed.

In mode 2, parity checking is performed for all bus masters and the DRAM operates at maximum speed when the MC68030 is bus master. When a parity error occurs in mode 2 and the MC68030 is the local bus master, the bus error signal is not activated during the current cycle. The bus error is activated during all subsequent MC68030 DRAM cycles. All other bus masters are notified of parity errors during the current cycle, consequently their DRAM access time increases by 1 clock.

In mode 3, parity checking is performed for all bus masters and parity errors are reported during the current cycle. In this mode, the DRAM access time is extended by one clock cycle to allow for parity checking.

MC68030 DRAM Accesses

The MC68030 is the default local bus master, therefore it is the local bus master as long as no other device requests local bus mastership.

5

PCC DRAM Accesses

When the PCC needs to transfer data, it requests local bus mastership from the multiport arbiter. When the PCC has been granted local bus mastership, it executes one bus cycle and then releases bus mastership. If a parity error is detected during a PCC to DRAM read cycle, a bus error is returned to the PCC.

VMEbus DRAM Accesses

When the VMEbus map decoder detects an onboard DRAM select, the VMEchip requests local bus mastership from the multiport arbiter. When the multiport arbiter has granted local bus mastership, a DRAM read or write cycle happens and the VMEchip activates the DTACK* (or BERR* if parity is enabled and a parity error occurs) signal on the VMEbus. If the VMEbus master is executing a read-modify-write cycle (RMC) to the DRAM, the multiport arbiter allows re arbitration of the local bus between the read and write portions of the sequence. It does not, however, allow the MC68030 to regain local bus mastership until both the read and write cycles have occurred to the DRAM.

When the VMEbus requests local bus mastership and the MC68030 is the current local bus master and it is executing a cycle that requires the VMEbus, then a dual port lockup condition occurs and the VMEchip signals a retry to the MC68030 by activating the BERR* and HALT* signal lines together. The MC68030 responds by aborting the current cycle, at which time it relinquishes local bus mastership so that the multiport arbiter can grant it to the VMEbus. When the VMEbus has finished with the DRAM, the multiport arbiter returns local bus mastership to the MC68030 and it retries the cycle that was aborted to allow the dual port access.

LANCE DRAM Accesses

When the LANCE needs to access DRAM it requests local bus mastership from the multiport arbiter. When granted, the LANCE performs up to 16 DRAM accesses, then gives up local bus mastership. If a parity error occurs while enabled, the DRAM controller indicates it by not activating LANRDY* to the LANCE. The LANCE sees this as a memory fault and gives up local bus mastership.

Refresh

The DRAM devices require that each of their 512 rows be refreshed once every 8 ms. To accomplish this, once every 15 μ s, the refresh timer requests that the RAM sequencer perform a Column Address Strobe (CAS) before Row Address Strobe (RAS) refresh cycle.

5

Local Bus Multiport Arbiter

Because the local address and data buses are used to access the onboard DRAM and the VMEbus, any devices that uses these resources must become the local bus master first. The MC68030 arbitration logic (Bus Request (BR*), Bus Grant (BG*), Bus Grant Acknowledge (BGACK*)) is used by the multiport arbiter to transfer local bus mastership from the current master to the next master. During normal operation the MC68030 is the local bus master.

When the PCC, the LANCE, or the VMEbus requests use of the local bus, the multiport arbiter activates BR* to the MC68030. The MC68030 responds by activating BG*, finishing its current cycle (if one is in progress), and giving up local bus mastership. At this point, the multiport arbiter grants local bus mastership to the highest priority requesting device. The granted device uses the local bus and then relinquishes local bus mastership. If another device is requesting local bus mastership at this time, the multiport arbiter grants it to the device, otherwise the MPU resumes local bus mastership. The arbitration priority in high order to low order is: LANCE, PCC, VMEbus, and MPU.

Reset

There are five sources of reset on the MVME147S.

SYSRESET*	Resets all onboard devices.
Power on Reset	Resets all onboard devices and drives SYSRESET* if this board is system controller.
Front Panel RESET	Resets all onboard devices and drives SYSRESET* if this board is system controller.
Remote Reset	When a remote switch is connected to front panel connector J4, it functions the same as the front panel RESET switch.
Watchdog Time-Out	Resets all onboard devices and drives SYSRESET* if this board is system controller.
MC68030 RESET Instruction	Does nothing.

Sources of Bus Error (BERR*)

The devices on the MVME147S that are capable of activating a local bus error are described below.

Local Bus Time-Out

A Local Bus Time-Out (LBTO) occurs whenever an MPU or PCC access (outside of the VMEbus range) does not complete within the programmed time. If the system is configured properly, this should only happen if software accesses a nonexistent location within the onboard address range. Whenever an LBTO occurs, the LBTO status bit is set in the VMEchip.

VMEbus Access Time-Out

A VMEbus Access Time-Out (VATO) occurs whenever a PCC or MC68030 VMEbus bound cycle does not receive a VMEbus BG within the programmed time. This is usually caused by another bus master holding the bus for an excessive period of time. When a VATO occurs, the VATO status bit is set in the VMEchip.

VMEbus BERR*

The VMEbus BERR* occurs when the BERR* signal line is activated on the VMEbus while the MC68030 or PCC is the VMEbus master. VMEbus BERR* should occur only if:

- ❑ An initialization routine samples to see if a device is present on the VMEbus and it is not
- ❑ Bad software accesses a nonexistent device within the VMEbus range
- ❑ Bad configuration tries to access a device on the VMEbus incorrectly (such as driving LWORD* low to a 16-bit board)
- ❑ A hardware error occurs on the VMEbus
- ❑ A VMEbus slave reports an access error (such as parity error)

Whenever a VMEbus BERR occurs, the VMEbus BERR status bit is set in the VMEchip.

Local RAM Parity Error

When parity checking is enabled, the current bus master receives a bus error (or no LANRDY*, if LANCE) if it is accessing the local DRAM and a parity error occurs. If the MC68030 is the local bus master when the parity error occurs, the Parity Error (PE) status bit is set in the PCC status register. Note that this bit is only useful if mode 3 parity checking is set. If mode 2 parity checking is set, the MC68030 is not able to read status after the occurrence of the parity error.

Bus Error Processing

Because different conditions can cause bus error exceptions, the software must be able to distinguish the source. To aid in this, the MVME147S provides status bits in the VMEchip and PCC chip.

Generally, the bus error handler can interrogate the status bits and proceed with the result. However, two conditions can corrupt the status bits:

1. An interrupt can happen during the execution of the bus error handler (before an instruction can write to the status register to raise the interrupt mask). If the interrupt service routine causes a second bus error, the status that indicates the source of the first bus error may be lost. The software must be written to deal with this. The PCC can be programmed to generate a Level 7 interrupt when a bus error occurs. This may help force the MC68030 to a known place when a bus error occurs.
2. The PCC can take a VMEbus bound BERR* (which updates the status bits) between the MC68030 receiving and handling of a bus error, or vice-versa.

MVME147S Support of MC68030 Indivisible Cycles

The MC68030 performs operations that require indivisible cycle sequences to the local DRAM and to the VMEbus. The MVME147S requires special circuitry to support these operations. Indivisible accesses to a single address are called Single Address Read-Modify-Write Cycles (SARMC). Indivisible accesses to multiple addresses are called Multiple Address Read-Modify-Write Cycles (MARMC).

SARMC cycles (caused by Test and Set (TAS) and single byte Compare and Swap (CAS) instructions) are supported fully by the MVME147S. This is possible because the VMEbus defines such cycles.

MARMC cycles (caused by CAS2 and multi-byte CAS instructions and by MMU table walking) are conditionally supported by the MVME147S. The VMEbus does not define these cycles.

The WAITRMC bit in the PCC controls the support of MARMC cycles. If WAITRMC is cleared, MARMC cycles are not guaranteed to be indivisible. Furthermore, if MARMC cycles straddle onboard DRAM and VMEbus memory, the MVME147S malfunctions.

If WAITRMC is set, MARMC cycles are guaranteed to be indivisible only if the other VMEbus board implements its MARMC cycles the same way as the MVME147S (with WAITRMC set). Note that setting the

WAITRMC bit can be a performance penalty. When the bit is set, the MVME147S waits to become VMEbus master before it executes any MARMC cycle (even though it may be going only to onboard DRAM).

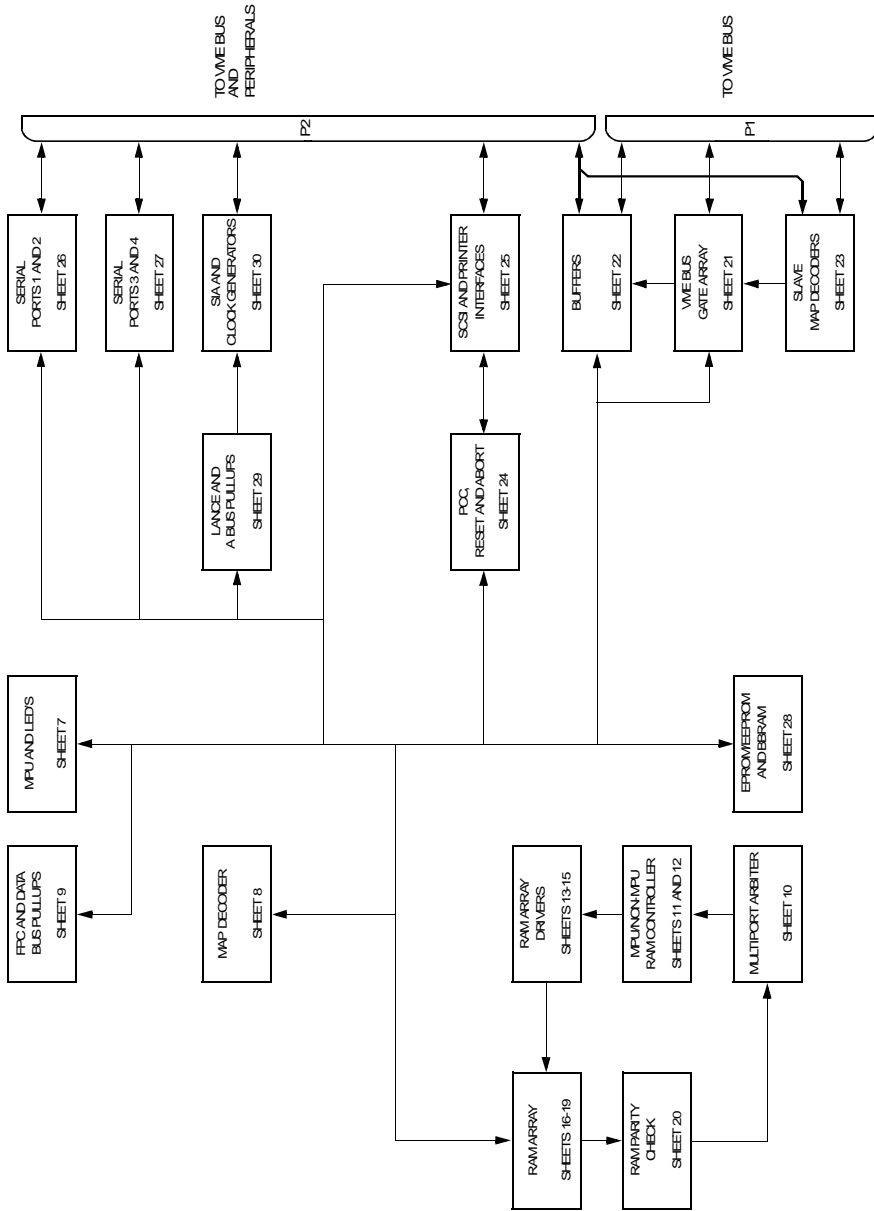

2730 0003

Figure 5-3. MVME147S Block Diagram

A

ABORT [3-1](#)
Abort Interrupt Control Register [4-12](#)
ABORT switch [3-2](#), [5-11](#), [5-19](#)
ABORT Switch (S1) [3-2](#)
AC Fail Interrupt Control Register [4-7](#)
AC Fail Interrupter [5-11](#)
Address Spaces [3-4](#)
address strobe [3-2](#)
Arbiter [5-3](#)
arbitration logic [5-21](#)
arbitration priority [5-21](#)
assert [1-8](#)
asterisk (*) [1-8](#)

B

Battery Backed Up RAM and Clock [5-14](#)
BBSY [5-3](#)
BERR [5-2](#)
BG [5-21](#)
BGACK [5-21](#)
Board Identification Register [4-41](#)
BR [5-21](#)
BRDFAIL bit [3-2](#)
Bus Busy [5-3](#)
Bus Error [5-2](#)
Bus Error Interrupt Control Register [4-11](#)
Bus Error Processing [5-23](#)
Bus Error Status Register [4-37](#)
Bus Grant [5-21](#)
Bus Grant Acknowledge [5-21](#)
Bus Request [5-21](#)
Byte Count Register [4-3](#)

C

CAS [5-24](#)
command chaining (scatter-gather) [5-7](#)
Compare and Swap [5-24](#)
Configuring the Interrupt Request Level [4-36](#)
Control and Status Registers [5-10](#)
Controls and Indicators [3-1](#)
Cooling Requirements [1-4](#)
Coprocesor Register Map [3-8](#)
CPU Address Space [3-7](#)

D

Data Address Register [4-1](#)
Data Bus Structure [5-13](#)
Data Holding Register [4-3](#)
Data Strobe [5-2](#)
data transfer state [5-8](#)
Device Timing Requirements [5-14](#)
Device Type [2-6](#)
direct [5-7](#)
DMA Channel Controller [5-7](#)
DMA Control and Status Register [4-11](#)
DMA Interrupt Control Register [4-10](#)
DMA Status Register [4-12](#)
DMAC [5-7](#)
DMAC Error Conditions [5-9](#)
DMAC Initiation Mode [5-7](#)
DMAC Operation States [5-8](#)
DRAM Accessed by the LANCE [4-19](#)
DRAM Address as Viewed from the VME-
bus [3-9](#), [4-17](#)
DRAM Addressed from the VMEbus [4-17](#)
DSO or DS1 [5-2](#)

E

EEPROM Power Up/Power Down Considerations 5-17
Encoding of the Interrupt ID 4-35
erasing writing to EEPROM 5-14
erasing/writing to EEPROM 2-4
Ethernet interface 5-1, 5-12
Ethernet station address 2-11, 5-12
Example DMA table 5-9

F

Factory Use Only Headers J5,J6 2-9
FAIL 3-2, 5-19
FAIL indicator 3-2
FAIL Indicator (DS1) 3-2
FCC Compliance 1-5
Features 1-2
Floating-Point Coprocessor 5-2
FPC 5-2
Front Panel Switches and Indicators 5-19
Functional Description 5-1
fuse (F1) 2-12

G

GCSR 3-11, 4-22
GCSR Base Address Configuration Register 4-37
General Description 1-6
General Purpose Control Register 4-14
General Purpose CSR 0 4-42
General Purpose CSR 1-4 4-42
General Purpose Status Register 4-16
Global Control and Status Register 4-22
Global Register 0 4-39
Global Register 1 4-40

H

Hardware Preparation 2-1
Header J3 2-9
Header Locations 2-3
Headers J1 and J2 2-4
Headers J5 and J6 2-9

Headers J8 and J9 2-10
hexadecimal 1-8

I

IACK 5-2
IACK and BG jumpers 2-12
IACK Daisy-Chain Driver 5-3
IACK signal line 3-12
IACKIN 3-12
IACKOUT 3-12
Idle State 5-8
idle state 5-8
indicator (DS1) 3-2
indicator (DS2) 3-2
indicator (DS3) 3-2
indicator (DS4) 3-2
indivisible cycle sequences 5-24
Installation Instructions 2-10
Interrupt Acknowledge 5-2
Interrupt Acknowledge Map 3-8
Interrupt Base Vector Register 4-20
Interrupt Handler 5-17
Interrupt Handler Mask Register 4-32
Interrupt Request Register 4-35

L

LAN Interrupt Control Register 4-15
LANCE 5-12, 5-21
LANCE DRAM Accesses 5-21
LBTO 5-22
LCSR 3-11, 4-23
LED indicators 5-19
Local Area Network Controller for Ethernet 5-12
Local Bus Multiport Arbiter 5-21
Local Bus Time-Out 5-4, 5-22
Local Control and Status Registers 4-23
Local I/O Devices 3-6
Local RAM Parity Error 5-23
local reset 3-1

M

Manual Terminology 1-8
MARMC 5-24
Master Address Modifier Register 4-32
Master Configuration Register 4-25
MC68030 DRAM Accesses 5-20
MC68030 Main Memory Map 3-5
MC68030 memory map 3-4
MC68030 MPU 5-1
MC68030 to VMEbus interface 5-2
MC68882 FPC 5-2
MC68882 Register Map 3-8
Memory Maps 3-4
memory write protection 5-14
Model Designations 1-1
Multiple Address Read-Modify-Write Cycles 5-24
MVME147S Block Diagram 5-26
MVME147S Interrupt Sources and Vectors 5-17
MVME147S Support of MC68030 Indivisible Cycles 5-24

N

negate 1-8

O

Onboard DRAM 5-19

P

parity 5-19
PCC 3-1, 4-1, 5-6, 5-10, 5-17, 5-21
PCC DRAM Accesses 5-20
PCC Overall View 4-1
Peripheral Channel Controller 3-1, 4-1, 5-6
power fail protection 5-14
Power Up Reset 5-11
Printer Control Register 4-9
Printer Data Register 4-21
Printer Interface 5-10
Printer Interrupt Control Register 4-8
Printer Status Register 4-22

prioritized 5-3
prioritized mode 5-3
Program and Data Address Spaces 3-5
Programmable Tick Timers 5-10
Programming the GCSR 4-39
Programming the LCSR 4-23
Programming the Peripheral Channel Controller 4-1
Programming the VMEchip 4-22

R

RAM Refresh Timer 5-11
Refresh 5-21
Remote Reset Switch Connector J4 3-1
RESET 3-1
Reset 5-22
RESET and ABORT Switches 5-11
RESET switch 5-11, 5-19
Reset switch 3-1
RESET Switch (S2) 3-1
Revision Level Register 4-21
ROM Configuration Select Headers J1,J2 2-4
ROM/PROM/EPROM/EEPROM 5-14
ROM/PROM/EPROM/EEPROM sockets 2-4
round-robin 5-3
round-robin mode 5-3
RUN 3-2, 5-19
RUN indicator 3-2
RUN indicator (DS3) 3-2

S

SARMC 5-24
SCC 5-11
SCON 3-2, 5-19
SCON indicator 3-1
SCON Indicator (DS4) 3-2
SCON LED 5-2
SCSI Chip Interface 5-10
SCSI Data Bus Converter 5-9
SCSI Interface 5-13
SCSI Port Interrupt Control Register 4-16

-
- SCSI Reset [5-9](#)
 - SCSI terminator power [2-12](#)
 - Serial Communications Controller [5-11](#)
 - Serial Interface Adapter [5-12](#)
 - Serial port 1 [5-11](#)
 - Serial port 2 [5-11](#)
 - Serial port 3 [5-11](#)
 - Serial port 4 [5-11](#)
 - Serial Port 4 Clock Configuration Select Headers J8,J9 [2-10](#)
 - Serial Port Interface [5-11](#)
 - Serial Port Interrupt Control Register [4-13](#)
 - SIA [5-12](#)
 - Single Address Read-Modify-Write Cycles [5-24](#)
 - Slave Address Modifier Register [4-30](#)
 - Slave Base Address Register [4-17](#)
 - Slave Configuration Register [4-28](#)
 - Sockets U1 and U15 [2-4](#)
 - Sockets U22 and U30 [2-4](#)
 - Software Interrupt 1 Control Register [4-19](#)
 - Software Interrupt 2 Control Register [4-21](#)
 - Sources of Bus Error [5-22](#)
 - specifications [1-3](#)
 - specifications, related [1-7](#)
 - STATUS [3-2](#), [5-19](#)
 - STATUS indicator [3-2](#)
 - STATUS Indicator (DS2) [3-2](#)
 - switch (S1) [3-2](#)
 - switch (S2) [3-1](#)
 - SYSCLK [5-2](#)
 - SYSFAIL inhibit bit [3-2](#)
 - SYSRESET [5-3](#), [5-19](#), [5-22](#)
 - System Clock [5-2](#)
 - system clock driver [5-3](#)
 - System Clock Utility [5-3](#)
 - System Control Select Header J3 [2-9](#)
 - system controller [2-9](#), [2-10](#), [3-2](#), [5-2](#)
 - System Controller Configuration Register [4-23](#)
 - system controller functions [5-2](#)
 - System Controller LED [5-2](#)
 - system reset [3-1](#)
 - System Reset Function [5-3](#)
- ## T
- Table Address Function Code Register [4-13](#)
 - Table Address Register [4-1](#)
 - Table Walk State [5-8](#)
 - table walk state [5-8](#)
 - TAS [5-24](#)
 - Test and Set [5-24](#)
 - time-of-day clock [5-14](#)
 - Timer 1 Control Register [4-5](#)
 - Timer 1 Counter Register [4-4](#)
 - Timer 1 Interrupt Control Register [4-5](#)
 - Timer 1 Preload Register [4-4](#)
 - Timer 2 Control Register [4-7](#)
 - Timer 2 Counter Register [4-4](#)
 - Timer 2 Interrupt Control Register [4-6](#)
 - Timer 2 Preload Register [4-4](#)
 - Timer Configuration Register [4-29](#)
 - Timings Guaranteed by MVME147S [5-15](#)
- ## U
- Unpacking Instructions [2-1](#)
 - Utility Interrupt Mask Register [4-33](#)
 - Utility Interrupt Vector Register [4-34](#)
- ## V
- VATO [5-22](#)
 - VMEbus Access Timeout [5-22](#)
 - VMEbus Accesses to MVME147S Onboard DRAM [3-9](#)
 - VMEbus and local time-out functions [5-2](#)
 - VMEbus BERR [5-23](#)
 - VMEbus control signal drivers and receivers [5-2](#)
 - VMEbus DRAM Accesses [5-20](#)
 - VMEbus Interrupt Acknowledge Map [3-12](#)
 - VMEbus interrupt handler [5-2](#)
 - VMEbus Interrupter [5-4](#)
 - VMEbus Master Interface [5-4](#)
 - VMEbus Memory Map [3-9](#)

VMEbus Requester 5-5
VMEbus Requester Configuration Register
4-24
VMEbus Short I/O Memory Map 3-11
VMEbus Slave Interface 5-6
VMEbus Status/ID Register 4-37
VMEbus System Controller 5-2
VMEbus Time-Out 5-2
VMEchip 4-1, 5-2
VMEchip as Viewed from the VMEbus 4-38
VMEchip GCSR 4-39
VMEchip GCSR as Viewed from the VME-
bus 3-11
VMEchip Global Control and Status Register
3-11
VMEchip Local Control and Status Register
3-11
VMEchip Local Control and Status Registers
4-23

W

Wait Read-Modify-Write Cycle 5-24
WAITMRC 5-24
Watchdog Timer 5-10
Watchdog Timer Control Register 4-8